

WR-112 Waveguide Electromechanical Relay Failsafe, X Band Switch SPDT/DPDT 10 GHz Max Freq., 7,000 Watts CPR Flat, 12V, Indicators

The FMWGS6068 WR112 waveguide electromechanical switch operates across a wide frequency range from 7.05 to 10 GHz and is configured for single pole double throw (SPDT) operation. A shorting plate on port 3 can be removed for optional double pole double throw (DPDT) operation. This innovative design features a failsafe actuator with TTL logic control, and a patented motor drive with arc suppression. The motor drive housing supports a viewable position indicator window and a cover that can be removed for manual override access. Impressive typical performance includes 0.04 dB insertion loss, 88 dB Isolation and 1.07:1 VSWR. The design operates across a temperature range of -40°C to +85°C, requires +12Vdc nominal bias voltage, and has an input power rating of up to 7 kW CW maximum, and an unpressurized peak power rating up to 202 kW. Operating life of 250K cycles minimum. The waveguide ports have CPR Flat flanges. The rugged package design is fully weatherized for up to 100% humidity exposure and supports a quick connect circular 6 pin MIL-SPEC DC bias connector with mate included.

Electrical Specifications

Switch Type	SPDT/DPDT
Actuator Type	Failsafe
Actuator Options	Window Indicator, Manual Override

Description	Min	Typ	Max	Units
Frequency Range	7.05		10	GHz
Impedance		50		Ohms
Operating Voltage	10.8	12	13.2	Volts
Actuating Current @ 12 Volts		250	300	mA
VSWR		1.07:1	1.1:1	
Insertion Loss		0.04	0.05	dB
Isolation	80	88		dB
Switching Time		<125		ms
Input Power (CW)			7	kWatts
Input Power (Peak/Unpressurized)			202	kWatts

Mechanical Specifications

Size	
Length	2.25 in [57.15 mm]
Width/Diameter	2.43 in [61.72 mm]
Height	4.85 in [123.19 mm]
Weight	1.43 lbs [648.64 g]
Operating Life	250,000 Cycles
Operating Pressure	30 psig

Configuration

Waveguide Size	WR-112
Flange Type	CPR Flat
Body Material and Plating	Aluminum, Black
Body Plating Specification	MIL-DTL-5541



Features:

- 7.05 to 10 GHz SPDT Waveguide Switch
- Optional DPDT Configuration
- WR112 Waveguide with CPR Flat Flanges
- Failsafe Actuator and Position Indicator
- Insertion Loss: 0.04 dB typ
- Isolation: 88 dB typ
- Switching Time: <125 msec typ
- +12 Vdc Nominal Voltage
- Input Power Rating up to 7 kW CW max
- Unpressurized Peak Power Rating up to 202 kW
- Manual Override Access
- Fully Weatherized Package
- Quick Connect Circular DC Connector with Mate
- -40°C to +85°C Operating Temperature

Applications:

- Electronic Warfare
- Electronic Countermeasures
- Microwave Radio
- VSAT
- Radar
- Space Systems
- Test Instrumentation
- Research and Development

Fairview Microwave
301 Leora Ln., Suite 100
Lewisville, TX 75056
Tel: 1-800-715-4396 / (972) 649-6678
Fax: (972) 649-6689
www.fairviewmicrowave.com
sales@fairviewmicrowave.com

Environmental Specifications

Temperature

Operating Range -40 to +85 deg C
Storage Range -55 to +100 deg C

Humidity 0 to 100% Fully Weatherized IAW IP67

Compliance Certifications (see [product page](#) for current document)

Plotted and Other Data

Notes:

Typical Performance Data

Typical (Position 1) Insertion Loss

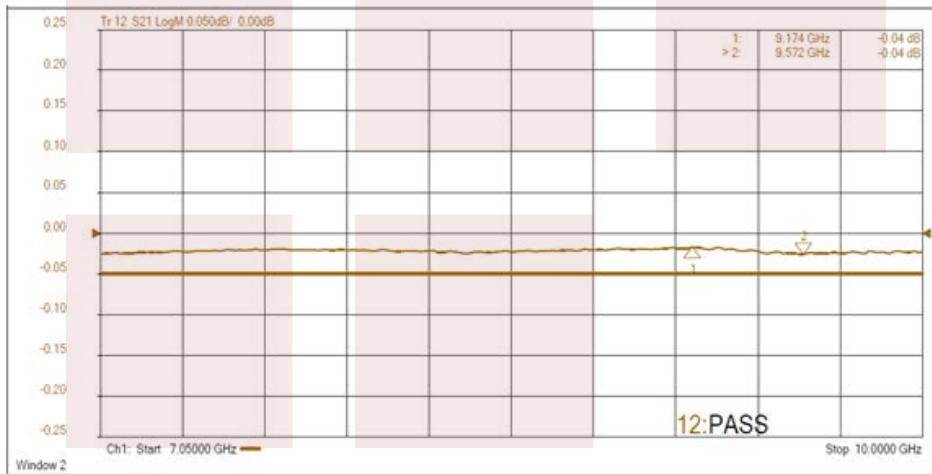

Typical (Position 2) Insertion Loss

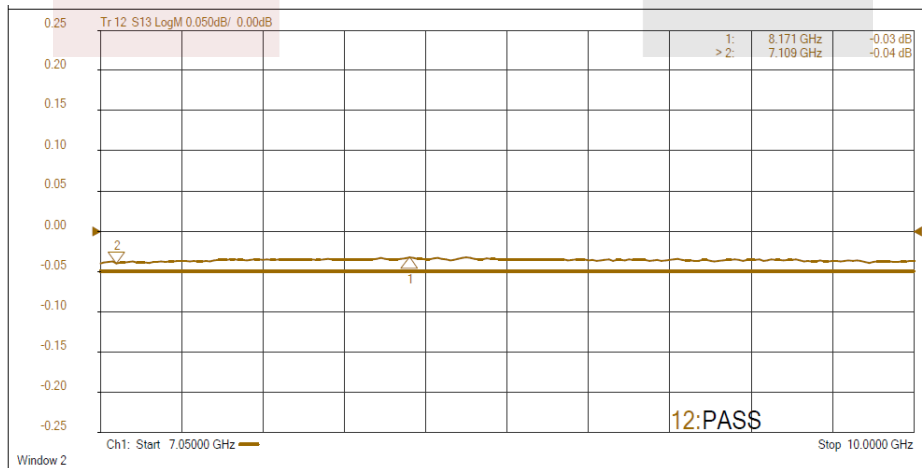

Typical (Position 1)
VSWR

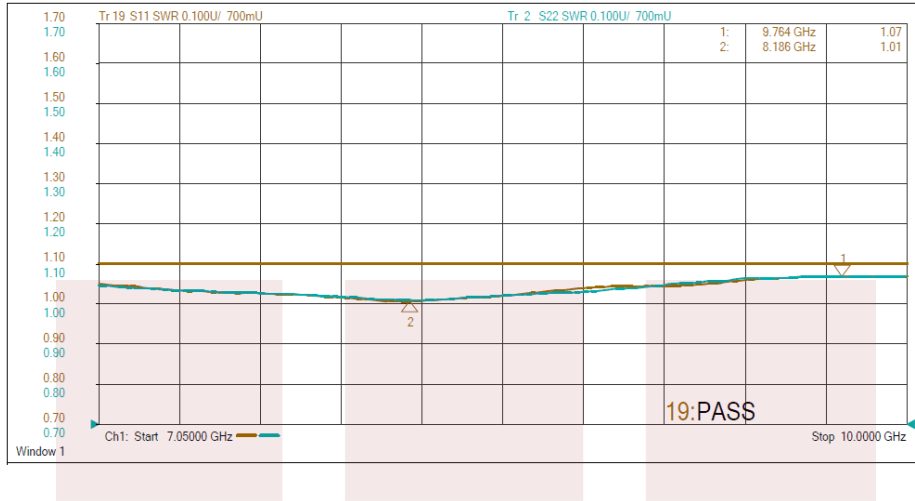

Typical (Position 2)
VSWR

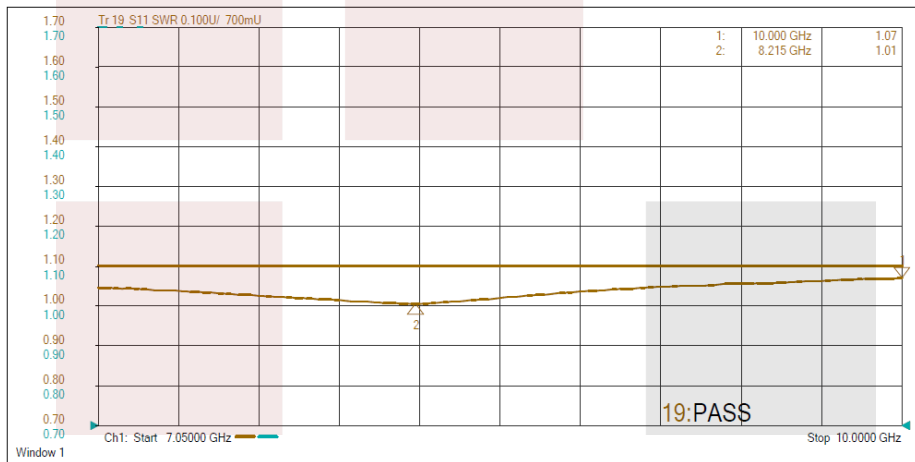



SUMMARY TEST DATA

**Typical (Position 1)
Isolation**

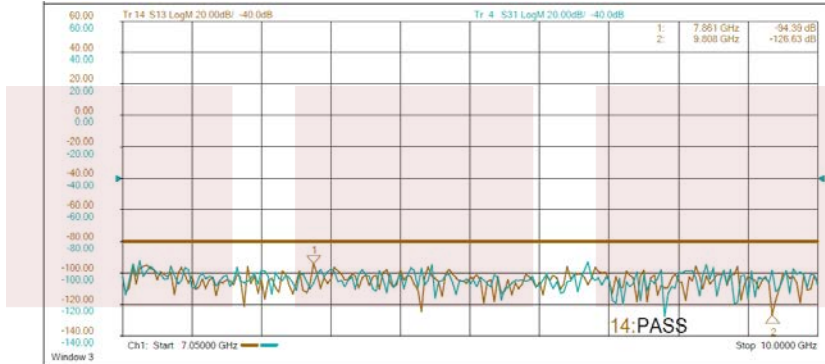

**Typical (Position 2)
Isolation**

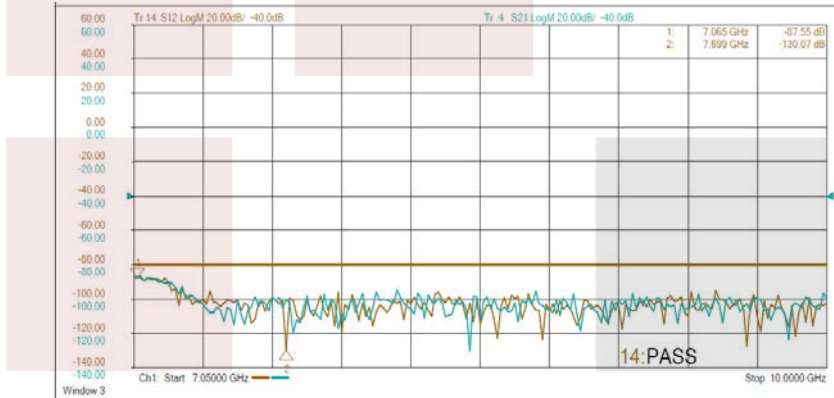

WR-112 Waveguide Electromechanical Relay Failsafe, X Band Switch SPDT/DPDT 10 GHz Max Freq., 7,000 Watts CPR Flat, 12V, Indicators from Fairview Microwave is in-stock and available to ship same-day. All of our RF/microwave products are available off-the-shelf from our ISO 9001:2008 certified facilities in Lewisville, Texas. Fairview Microwave is RF on-demand.

For additional information on this product, please click the following link: [WR-112 Waveguide Electromechanical Relay Failsafe, X Band Switch SPDT/DPDT 10 GHz Max Freq., 7,000 Watts CPR Flat, 12V, Indicators FMWGS6068](#)

URL: <https://www.fairviewmicrowave.com/wr-112-waveguide-electromechanical-relay-failsafe-switch-spdt-dpdt-10-ghz-fmwgs6068-p.aspx>

The information contained in this document is accurate to the best of our knowledge and representative of the part described herein. It may be necessary to make modifications to the part and/or the documentation of the part, in order to implement improvements. Fairview Microwave reserves the right to make such changes as required. Unless otherwise stated, all specifications are nominal. Fairview Microwave does not make any representation or warranty regarding the suitability of the part described herein for any particular purpose, and Fairview Microwave does not assume any liability arising out of the use of any part or documentation.



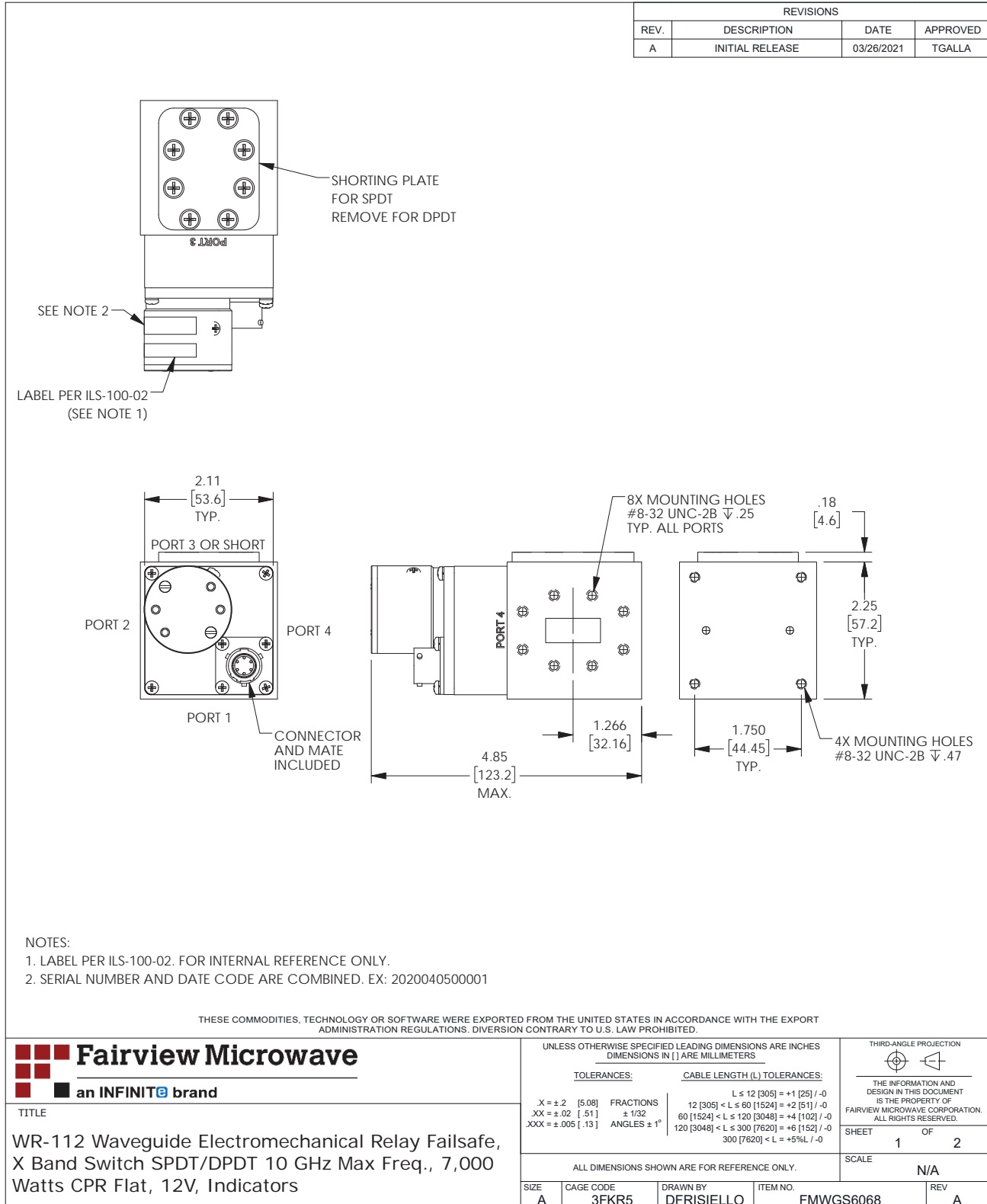

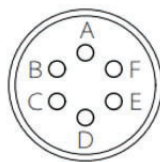
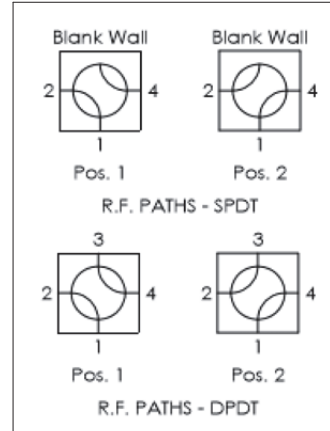
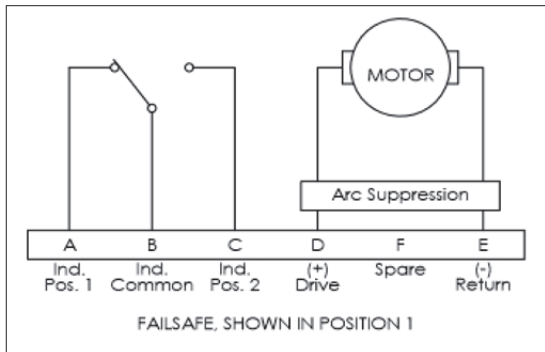

View A

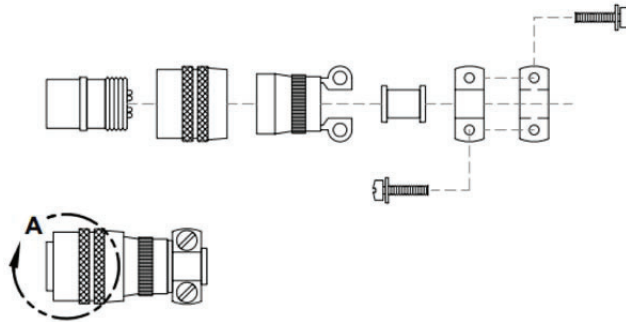

THESE COMMODITIES, TECHNOLOGY OR SOFTWARE WERE EXPORTED FROM THE UNITED STATES IN ACCORDANCE WITH THE EXPORT ADMINISTRATION REGULATIONS. DIVERSION CONTRARY TO U.S. LAW PROHIBITED.

TITLE
WR-112 Waveguide Electromechanical Relay Failsafe,
X Band Switch SPDT/DPDT 10 GHz Max Freq., 7,000
Watts CPR Flat, 12V, Indicators

UNLESS OTHERWISE SPECIFIED LEADING DIMENSIONS ARE INCHES
DIMENSIONS IN [] ARE MILLIMETERS

TOLERANCES:		CABLE LENGTH (L) TOLERANCES:	
X = ± 2 [5.08]	FRACTIONS ± 1/32	L ≤ 12 [305] = +1 [25] / -0	
.XX = ± 0.02 [.51]	ANGLES ± 1°	12 [305] < L ≤ 60 [1524] = +2 [51] / -0	
XXX = ± 0.005 [.13]		60 [1524] < L ≤ 120 [3048] = +4 [102] / -0	
		120 [3048] < L ≤ 300 [7620] = +6 [152] / -0	
		300 [7620] < L = +5%L / -0	

THIRD-ANGLE PROJECTION
THE INFORMATION AND DESIGN IN THIS DOCUMENT IS THE PROPERTY OF FAIRVIEW MICROWAVE CORPORATION. ALL RIGHTS RESERVED.

SHEET 2 OF 2

ALL DIMENSIONS SHOWN ARE FOR REFERENCE ONLY.

SCALE N/A

SIZE A	CAGE CODE 3FKR5	DRAWN BY DFRISIELLO	ITEM NO. FMWGS6068	REV A
--------	-----------------	---------------------	--------------------	-------

T-Rev.D