

WR-90 Waveguide Electromechanical Relay Failsafe, X Band Switch SPDT/DPDT 12.4 GHz Max Freq., 5,000 Watts CPR Flat, 12V, Indicators

The FMWGS6064 WR-90 waveguide electromechanical switch operates across a wide frequency range from 8.2 GHz to 12.4 GHz and is configured for single pole double throw (SPDT) operation. A shorting plate on port 3 can be removed for optional double pole double throw (DPDT) operation. This innovative design features a failsafe actuator and patented motor drive with arc suppression. The motor drive housing supports a viewable position indicator window and a cover that can be removed for manual override access. Impressive performance includes 0.05 dB insertion loss, 85 dB Isolation and 1.06:1 VSW. The design operates across a temperature range of -40°C to +85°C, requires +12Vdc nominal bias voltage, and has an input power rating of up to 5 kW CW maximum, and an unpressurized peak power rating of 123 kW. Operating life of 250K cycles minimum. The waveguide ports have CPR-Flat Flanges. The rugged package design is fully weatherized for up to 100% humidity exposure and supports a quick connect circular 6 pin MIL-SPEC DC bias connector with mate included.



Features:

- 8.2 to 12.4 GHz SPDT Waveguide Switch
- Optional DPDT Configuration
- WR-90 Waveguide with CPR-Flat Flanges
- Failsafe Actuator and Position Indicator
- Insertion Loss: 0.05 dB typ
- Isolation: 85 dB typ
- Switching Time: <100 msec typ
- +12 Vdc Nominal Voltage
- Input Power Rating up to 5 kW CW max
- Unpressurized Power Rating up to 123 kW Peak
- Manual Override Access
- Fully Weatherized Package
- Quick Connect Circular DC Connector with Mate
- -40°C to +85°C Operating Temperature

Electrical Specifications

Switch Type	SPDT/DPDT
Actuator Type	Failsafe
Actuator Options	Window Indicator, Manual Override

Description	Min	Typ	Max	Units
Frequency Range	8.2		12.4	GHz
Impedance		50		Ohms
Operating Voltage	10.8	12	13.2	Volts
Actuating Current @ 12 Volts		250	300	mA
VSWR		1.06:1	1.1:1	
Insertion Loss		0.05	0.07	dB
Isolation	80	85		dB
Switching Time		<100		ms
Input Power (CW)			5	kWatts
Input Power (Peak/Unpressurized)			123	kWatts

Mechanical Specifications

Size	
Length	2.25 in [57.15 mm]
Width/Diameter	2.41 in [61.21 mm]
Height	4.5 in [114.3 mm]
Weight	1.28 lbs [580.6 g]
Operating Life	250,000 Cycles
Operating Pressure	30 psig

Configuration

Waveguide Size	WR-90
Flange Type	CPR Flat
Body Material and Plating	Aluminum, Black
Body Plating Specification	MIL-DTL-5541

Applications:

- Electronic Warfare
- Electronic Countermeasures
- Microwave Radio
- VSAT
- Radar
- Space Systems
- Test Instrumentation
- Research and Development

Fairview Microwave
301 Leora Ln., Suite 100
Lewisville, TX 75056
Tel: 1-800-715-4396 / (972) 649-6678
Fax: (972) 649-6689
www.fairviewmicrowave.com
sales@fairviewmicrowave.com

Environmental Specifications

Temperature

Operating Range -40 to +85 deg C
Storage Range -55 to +100 deg C

Humidity 0 to 100% Fully Weatherized IAW IP67

Compliance Certifications (see [product page](#) for current document)

Plotted and Other Data

Notes:

Typical Performance Data

Typical (Position 1) Insertion Loss

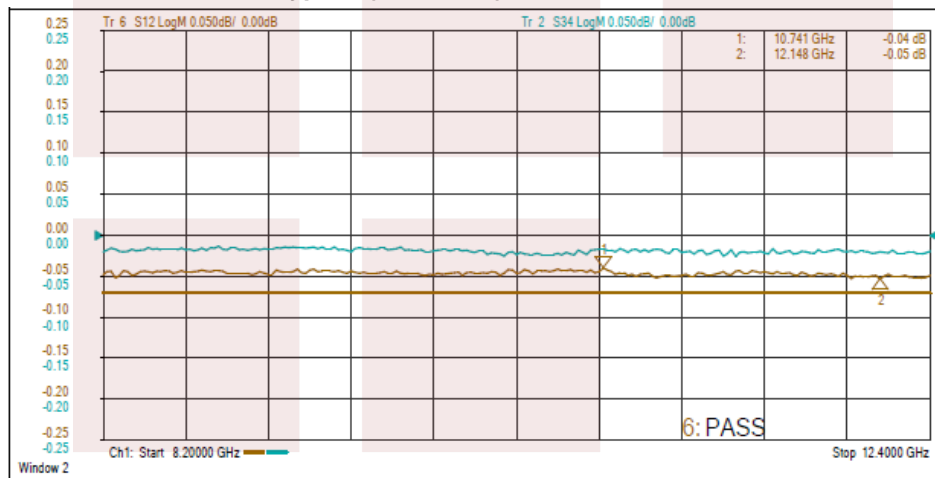

Typical (Position 2) Insertion Loss

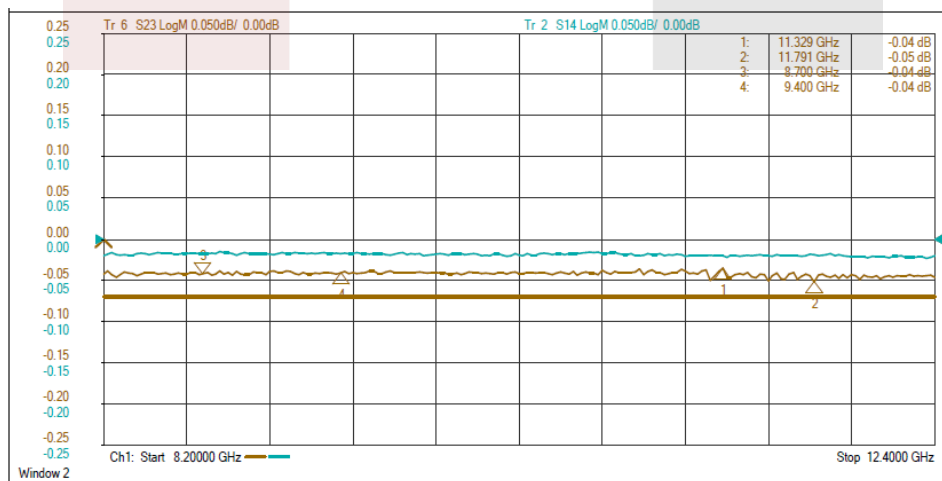

Typical (Position 1)
VSWR

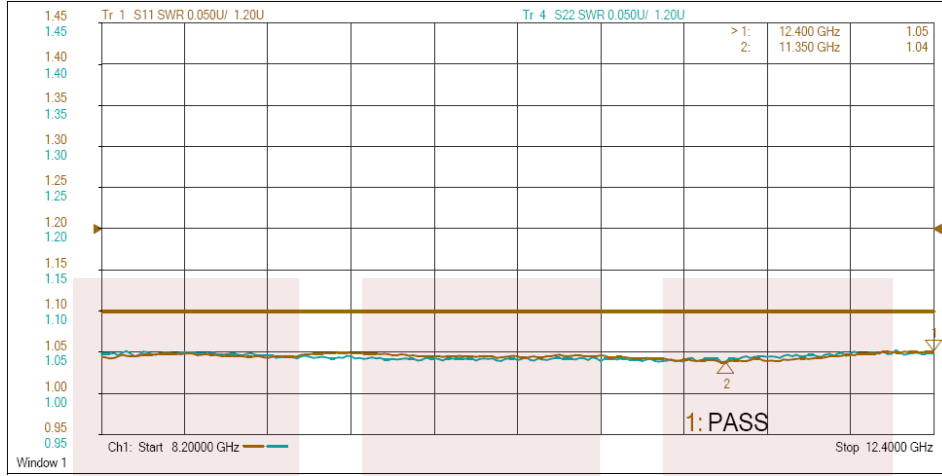

Typical (Position 2)
VSWR

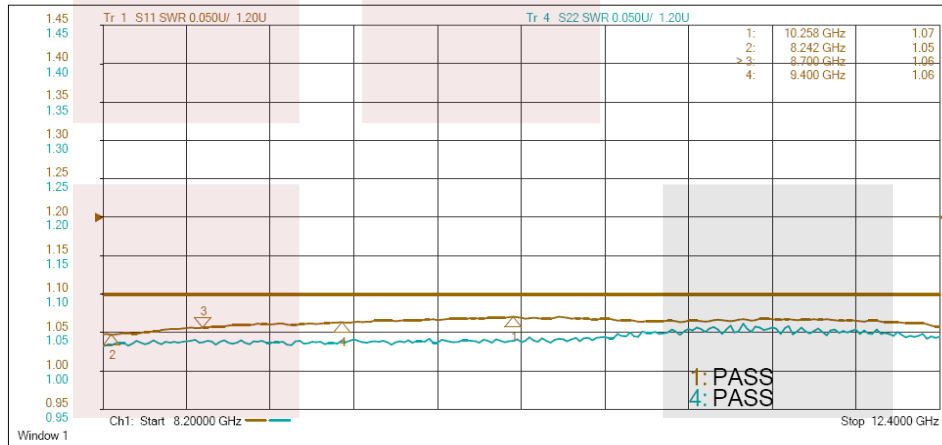

**Typical (Position 1)
Isolation**

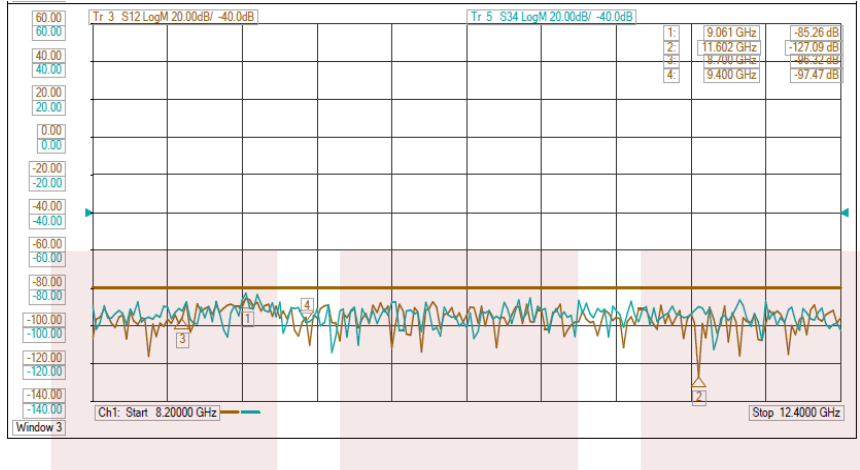

**Typical (Position 2)
Isolation**

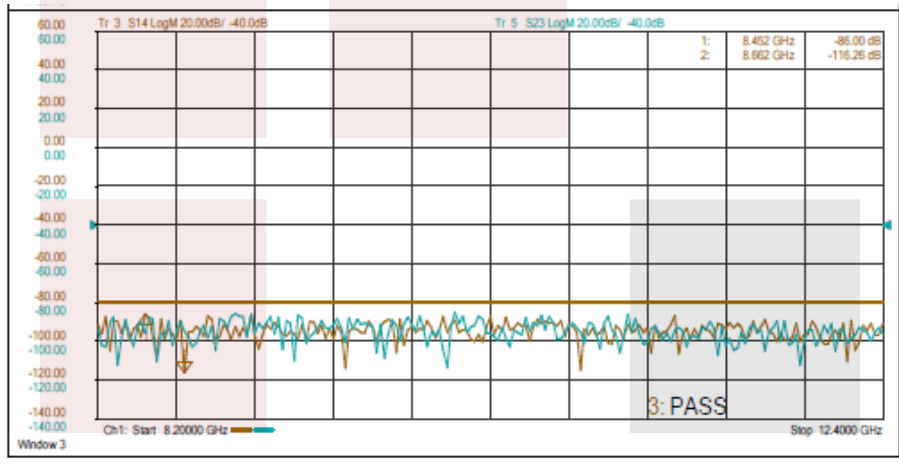

WR-90 Waveguide Electromechanical Relay Failsafe, X Band Switch SPDT/DPDT 12.4 GHz Max Freq., 5,000 Watts CPR Flat, 12V, Indicators from Fairview Microwave is in-stock and available to ship same-day. All of our RF/microwave products are available off-the-shelf from our ISO 9001:2008 certified facilities in Lewisville, Texas. Fairview Microwave is RF on-demand.

For additional information on this product, please click the following link: [WR-90 Waveguide Electromechanical Relay Failsafe, X Band Switch SPDT/DPDT 12.4 GHz Max Freq., 5,000 Watts CPR Flat, 12V, Indicators FMWGS6064](#)

URL: <https://www.fairviewmicrowave.com/wr-90-waveguide-electromechanical-relay-failsafe-switch-spdt-dpdt-12.4-ghz-fmwgs6064-p.aspx>

The information contained in this document is accurate to the best of our knowledge and representative of the part described herein. It may be necessary to make modifications to the part and/or the documentation of the part, in order to implement improvements. Fairview Microwave reserves the right to make such changes as required. Unless otherwise stated, all specifications are nominal. Fairview Microwave does not make any representation or warranty regarding the suitability of the part described herein for any particular purpose, and Fairview Microwave does not assume any liability arising out of the use of any part or documentation.



REVISIONS			
REV.	DESCRIPTION	DATE	APPROVED
A	INITIAL RELEASE	03/26/2021	TGALLA

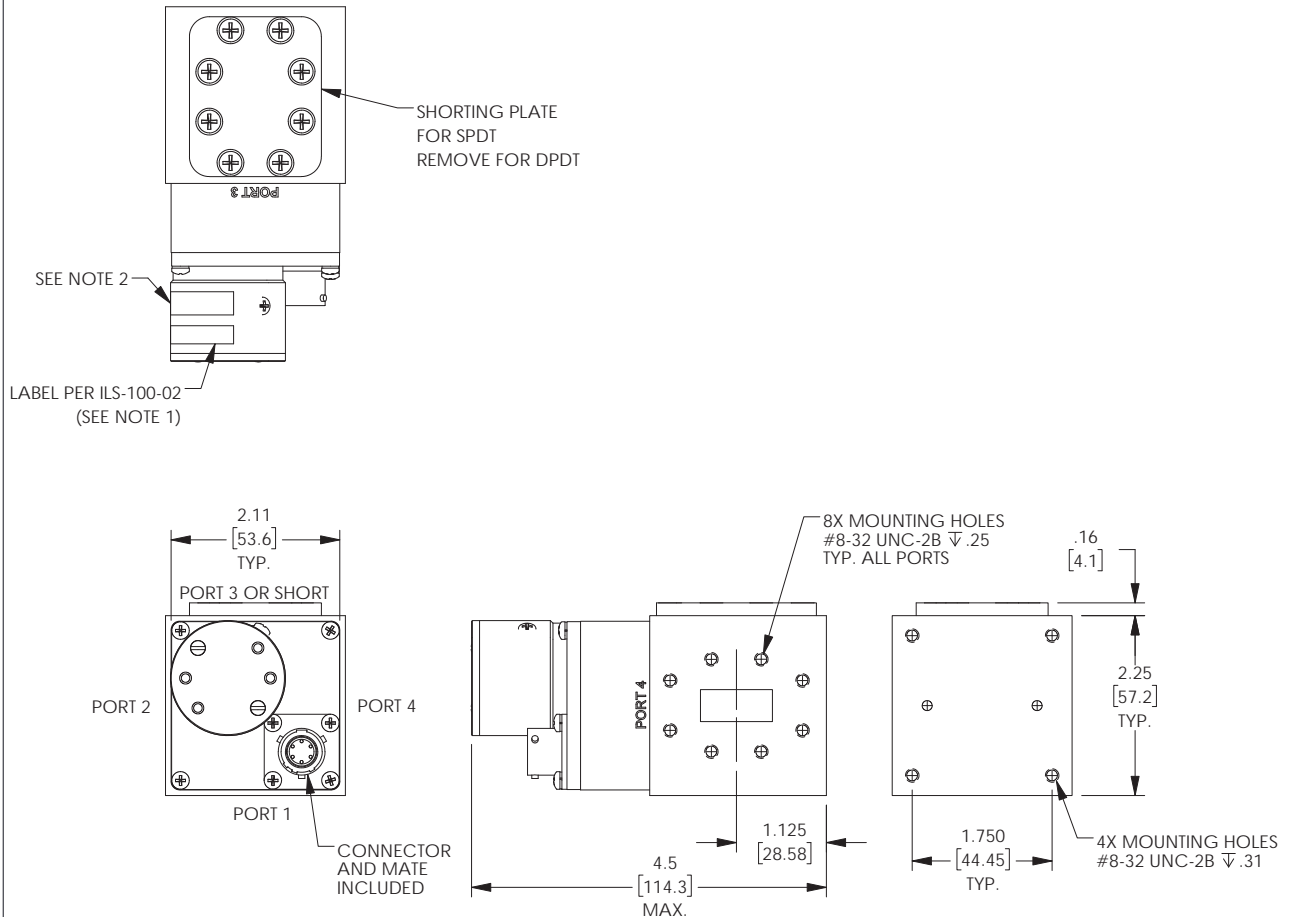

- NOTES:
 1. LABEL PER ILS-100-02. FOR INTERNAL REFERENCE ONLY.
 2. SERIAL NUMBER AND DATE CODE ARE COMBINED. EX: 2020040500001

THESE COMMODITIES, TECHNOLOGY OR SOFTWARE WERE EXPORTED FROM THE UNITED STATES IN ACCORDANCE WITH THE EXPORT ADMINISTRATION REGULATIONS. DIVERSION CONTRARY TO U.S. LAW PROHIBITED.

TITLE
 WR-90 Waveguide Electromechanical Relay Failsafe, X Band Switch SPDT/DPDT 12.4 GHz Max Freq., 5,000 Watts CPR Flat, 12V, Indicators

UNLESS OTHERWISE SPECIFIED LEADING DIMENSIONS ARE INCHES
 DIMENSIONS IN [] ARE MILLIMETERS

TOLERANCES:		CABLE LENGTH (L) TOLERANCES:	
.X = ± 2 [5.08]	FRACTIONS ± 1/32	L ≤ 12 [305] = +1 [25] / -0	
.XX = ± 0.02 [.51]	ANGLES ± 1°	12 [305] < L ≤ 60 [1524] = +2 [51] / -0	
.XXX = ± 0.005 [.13]		60 [1524] < L ≤ 120 [3048] = +4 [102] / -0	
		120 [3048] < L ≤ 300 [7620] = +6 [152] / -0	
		300 [7620] < L = +5%L / -0	

THIRD-ANGLE PROJECTION

 THE INFORMATION AND DESIGN IN THIS DOCUMENT IS THE PROPERTY OF FAIRVIEW MICROWAVE CORPORATION. ALL RIGHTS RESERVED.

ALL DIMENSIONS SHOWN ARE FOR REFERENCE ONLY.				SCALE	N/A
SIZE	CAGE CODE	DRAWN BY	ITEM NO.	REV	
A	3FKR5	DFRISIELLO	FMWGS6064	A	

T-Rev.D

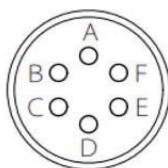
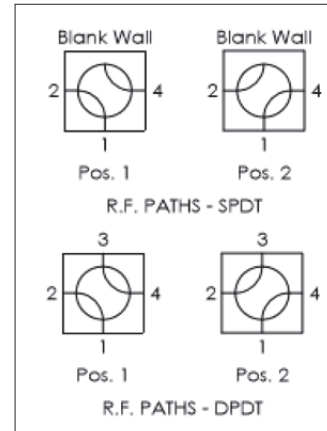
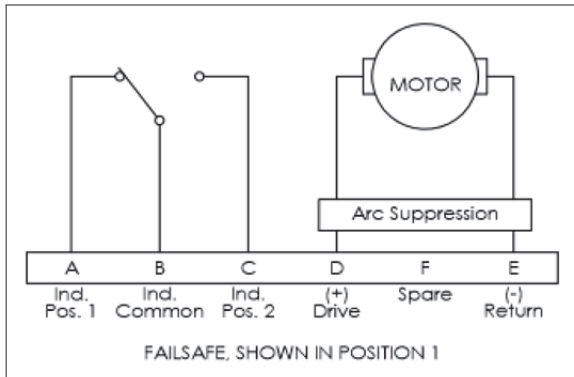

View A

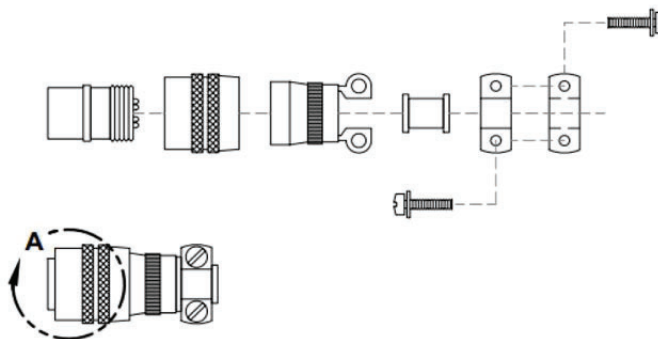

THESE COMMODITIES, TECHNOLOGY OR SOFTWARE WERE EXPORTED FROM THE UNITED STATES IN ACCORDANCE WITH THE EXPORT ADMINISTRATION REGULATIONS. DIVERSION CONTRARY TO U.S. LAW PROHIBITED.

TITLE
WR-90 Waveguide Electromechanical Relay Failsafe, X Band Switch SPDT/DPDT 12.4 GHz Max Freq., 5,000 Watts CPR Flat, 12V, Indicators

UNLESS OTHERWISE SPECIFIED LEADING DIMENSIONS ARE INCHES
DIMENSIONS IN [] ARE MILLIMETERS

TOLERANCES: CABLE LENGTH (L) TOLERANCES:

$X = \pm 2$ [5.08]	FRACTIONS	$L \leq 12$ [305] = +1 [25] / -0
$.XX = \pm 0.02$ [.51]	$\pm 1/32$	12 [305] < $L \leq 60$ [1524] = +2 [51] / -0
$.XXX = \pm 0.005$ [.13]	ANGLES $\pm 1^\circ$	60 [1524] < $L \leq 120$ [3048] = +4 [102] / -0
		120 [3048] < $L \leq 300$ [7620] = +6 [152] / -0
		300 [7620] < $L = +5\%L$ / -0

THIRD-ANGLE PROJECTION



THE INFORMATION AND DESIGN IN THIS DOCUMENT IS THE PROPERTY OF FAIRVIEW MICROWAVE CORPORATION. ALL RIGHTS RESERVED.

SHEET 2 OF 2

ALL DIMENSIONS SHOWN ARE FOR REFERENCE ONLY.

SCALE N/A

SIZE A	CAGE CODE 3FKR5	DRAWN BY DFRISIELLO	ITEM NO. FMWGS6064	REV A
-----------	--------------------	------------------------	-----------------------	----------

T-Rev.D