

WR-8 Waveguide Section 12 Inch Straight Length with UG-387/U-Mod Round Cover Flange from 90 GHz to 140 GHz

Fairview's Microwave FMW08S000-12 is a 12 inch WR-8 straight waveguide section that operates from 90 GHz to 140 GHz. This straight waveguide section offers a typical 1.2 dB insertion loss and a typical 1.15 VSWR. The input of this straight waveguide section has a UG-387/U-M Flange. FMW08S000-12 is part of over 40,000 RF, microwave and millimeter wave components. WR-8 straight waveguide section will ship worldwide the same day it is purchased along with our other RF components.

Electrical Specifications*

Description	Min	Typ	Max	Units
Frequency Range	90		140	GHz
VSWR		1.15:1		
Insertion Loss		1.2		dB

* Values at 25°C, sea level

Mechanical Specifications

Waveguide Size	WR-8
Section Length	12 in [304.8 mm]
Flange 1	
Flange Type	Round Cover
Flange Designation	UG-387/U-Mod
Material	Oxygen Free Hard Copper
Plating	Gold
Waveguide	
Interface	WR-8
Material	Oxygen Free Hard Copper
Plating	Gold
Flange 2	
Flange Type	Round Cover
Flange Designation	UG-387/U-Mod
Material	Oxygen Free Hard Copper
Plating	Gold
Size	
Weight	0.056 lbs [25.4 g]

Compliance Certifications (see [product page](#) for current document)

Plotted and Other Data

Notes:

- Values at 25 °C, sea level



Features:

- 12" Length
- WR-8 Waveguide
- UG-387/U-M Flange
- 90 GHz to 140 GHz Frequency Range
- Comprehensive waveguide offering also includes E-Bends, H-Bends, Waveguide to Coax Adapters, Filters, Terminations, and more.

Fairview Microwave
 301 Leora Ln., Suite 100
 Lewisville, TX 75056
 Tel: 1-800-715-4396 / (972) 649-6678
 Fax: (972) 649-6689
www.fairviewmicrowave.com
sales@fairviewmicrowave.com

WR-8 Waveguide Section 12 Inch Straight Length with UG-387/U-Mod Round Cover Flange from 90 GHz to 140 GHz from Fairview Microwave is in-stock and available to ship same-day. All of our RF/microwave products are available off-the-shelf from our ISO 9001:2008 certified facilities in Allen, Texas. Fairview Microwave is RF on-demand.

For additional information on this product, please click the following link: [WR-8 Waveguide Section 12 Inch Straight Length with UG-387/U-Mod Round Cover Flange from 90 GHz to 140 GHz FMW08S000-12](#)

URL: <https://www.fairviewmicrowave.com/wr-8-waveguide-section-straight-ug387-mod-round-fmw08s000-12-p.aspx>

The information contained in this document is accurate to the best of our knowledge and representative of the part described herein. It may be necessary to make modifications to the part and/or the documentation of the part, in order to implement improvements. Fairview Microwave reserves the right to make such changes as required. Unless otherwise stated, all specifications are nominal. Fairview Microwave does not make any representation or warranty regarding the suitability of the part described herein for any particular purpose, and Fairview Microwave does not assume any liability arising out of the use of any part or documentation.



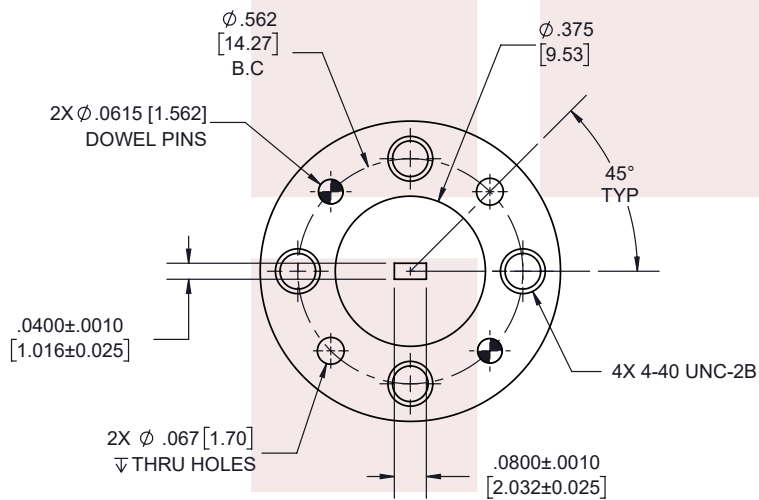
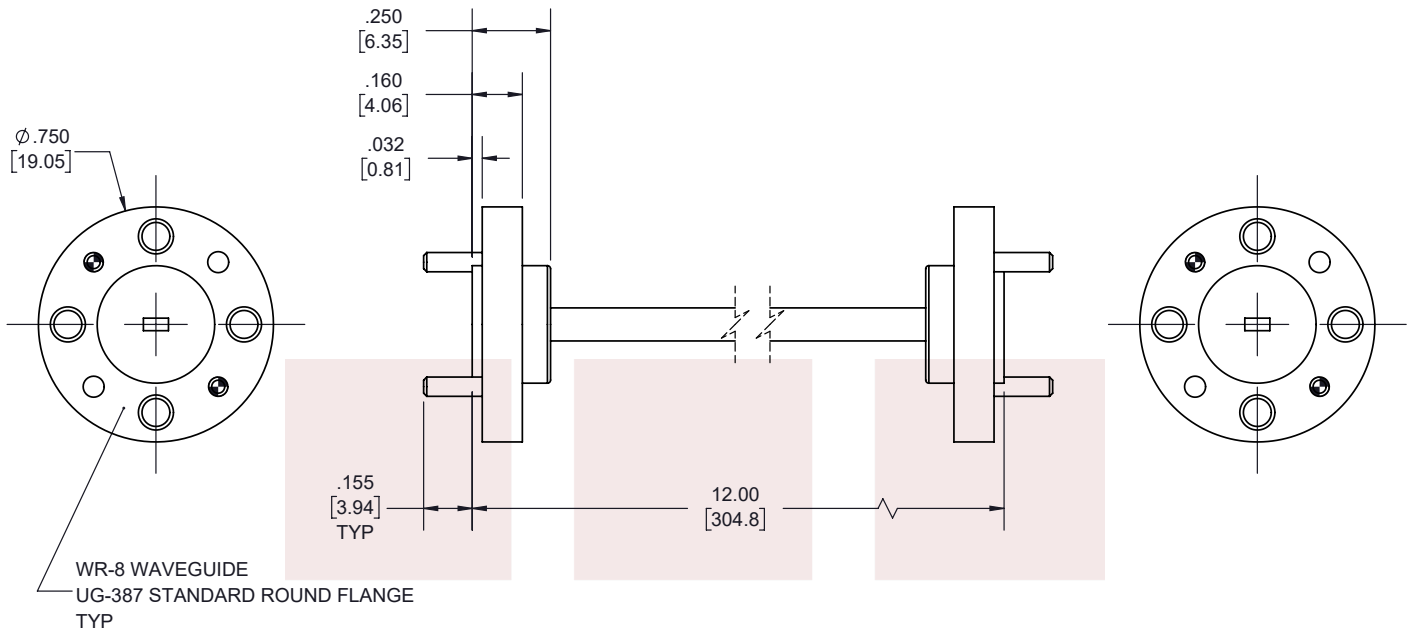

FLANGE DETAIL

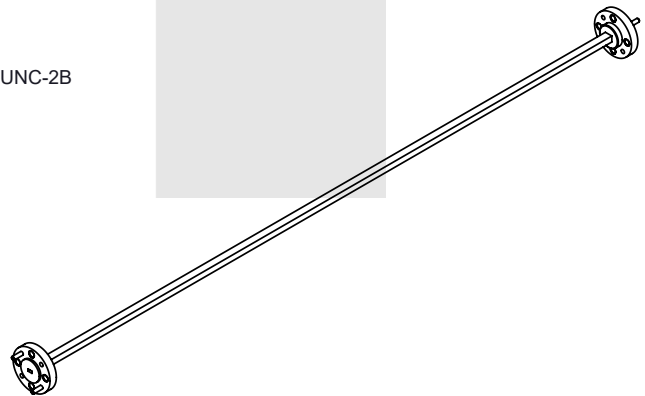

STANDARD TOLERANCES

- .X ±0.2
- .XX ±0.01
- .XXX ±0.005

*STANDARD TOLERANCES APPLY ONLY TO DIMENSIONS IN INCHES

<p>Fairview Microwave an INFINIT® brand</p>		<p>NOTES: 1. UNLESS OTHERWISE SPECIFIED ALL DIMENSIONS ARE NOMINAL. 2. ALL SPECIFICATIONS ARE SUBJECT TO CHANGE WITHOUT NOTICE AT ANY TIME. 3. DIMENSIONS ARE IN INCHES [mm].</p>						
<p>TITLE WR-8 Waveguide Section 12 Inch Straight Length with UG-387/U-Mod Round Cover Flange from 90 GHz to 140 GHz</p>		<p>DWG NO FMW08S000-12</p>		<p>CAGE CODE 3FKR5</p>				
CAD FILE	08/05/19	SHEET	1 OF 1	SCALE	N/A	SIZE	A	7361