

0.2 MHz to 3 GHz Surface Mount (SMT) Noise Source Module, Output ENR of 31 dB, +12 VDC, Pin Packaged

The FMNS4002 is a surface mount packaged noise source which operates over a frequency range from 200 KHz to 3 GHz. This module is particularly useful in circuit board applications used for built-in test equipment, dithering for increased dynamic range of A/D converters, and as a source for bit error rate testing. This module operates at +12 Vdc and features a high output ENR level of 31 dB. The output White Gaussian Noise has a minimum power level of -143 dBm/Hz. Maximum flatness across the entire frequency band is +/-1.50 dB. Operating temperature range is -40°C to +85°C with a temperature coefficient of 0.01 dB/°C. The small surface mount package outline uses 8 gull wing leads. For the circuit board layout, a through hole mounting footprint diagram is included for reference.



Electrical Specifications

Description	Min	Typ	Max	Units
Frequency Range	0.0002		3	GHz
Impedance		50		Ohms
Output ENR	31			dB
Flatness			±1.5	dB
Supply Voltage Sensitivity		0.1		dB/%V
Thermal Sensitivity		0.01		dB/deg C
Noise Power Spectral Density	-143			dBm/Hz
Bias Voltage 1		12		Volts
Damage Level for Bias 1			24	Volts
Input Current 1			10	mA
Crest Factor		5:1		

Mechanical Specifications

Size	
Length	0.815 in [20.7 mm]
Width/Dia.	0.595 in [15.11 mm]
Height	0.255 in [6.48 mm]
Weight	0.01 lbs [4.54 g]
Package Type	Surface Mount
Connectors	
DC Connector	Pin

Environmental Specifications

Temperature	
Operating Range	-40 to +85 °C
Storage Range	-65 to +150 °C

Compliance Certifications (see [product page](#) for current document)

Plotted and Other Data

Notes:

Features:

- Surface Mount Packaged Noise Source module
- Frequency Range: 200 KHz to 3 GHz
- High Output ENR level: 31 dB
- White Gaussian Noise Output
- Minimum power level -143 dBm/Hz
- Maximum Flatness +/- 1.50 dB
- Small Package Outline with 8 gullwing leads
- DC Voltage: +12 Vdc
- -40°C to +85°C Operating Temperature
- Crest Factor: 5:1

Applications:

- Noise Figure Test & Measurement
- Built-In Test Equipment
- Dithering for Increased Dynamic Range for A/D Converters
- Source for Bit Error Rate Testing

Fairview Microwave
 301 Leora Ln., Suite 100
 Lewisville, TX 75056
 Tel: 1-800-715-4396 / (972) 649-6678
 Fax: (972) 649-6689
www.fairviewmicrowave.com
sales@fairviewmicrowave.com

Typical Performance Data

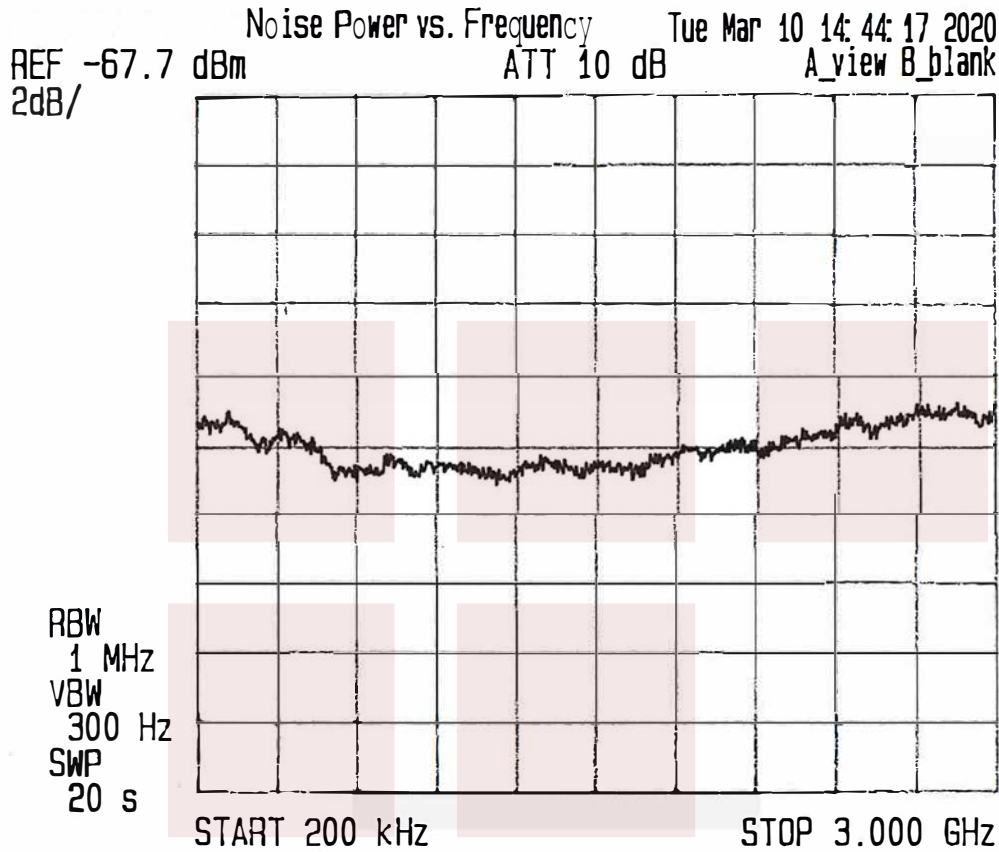

0.2 MHz to 3 GHz Surface Mount (SMT) Noise Source Module, Output ENR of 31 dB, +12 VDC, Pin Packaged from Fairview Microwave is in-stock and available to ship same-day. All of our RF/microwave products are available off-the-shelf from our ISO 9001:2008 certified facilities in Lewisville, Texas. Fairview Microwave is RF on-demand.

Click the following link to obtain additional part information: [0.2 MHz to 3 GHz Surface Mount \(SMT\) Noise Source Module, Output ENR of 31 dB, +12 VDC, Pin Packaged FMNS4002](https://www.fairviewmicrowave.com/noise-source-enr-31-db-3-ghz-fmns4002-p.aspx)

URL: <https://www.fairviewmicrowave.com/noise-source-enr-31-db-3-ghz-fmns4002-p.aspx>

The information contained in this document is accurate to the best of our knowledge and representative of the part described herein. It may be necessary to make modifications to the part and/or the documentation of the part, in order to implement improvements. Fairview Microwave reserves the right to make such changes as required. Unless otherwise stated, all specifications are nominal. Fairview Microwave does not make any representation or warranty regarding the suitability of the part described herein for any particular purpose, and Fairview Microwave does not assume any liability arising out of the use of any part or documentation.

REVISIONS			
REV.	DESCRIPTION	DATE	APPROVED
A	INITIAL RELEASE	6/8/2020	TGALLA

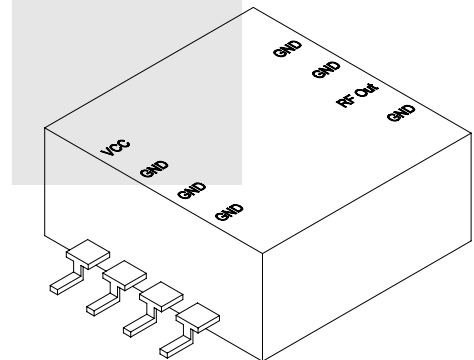
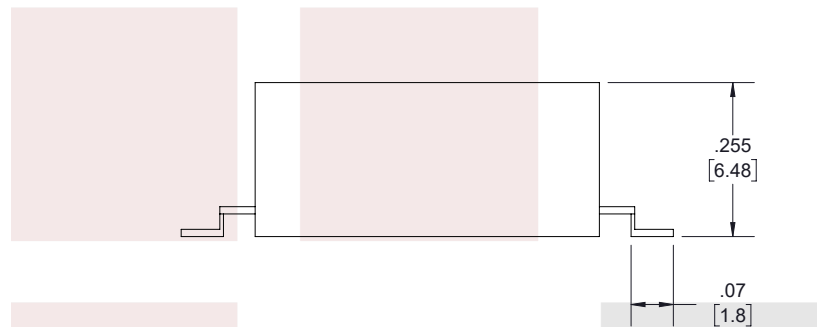
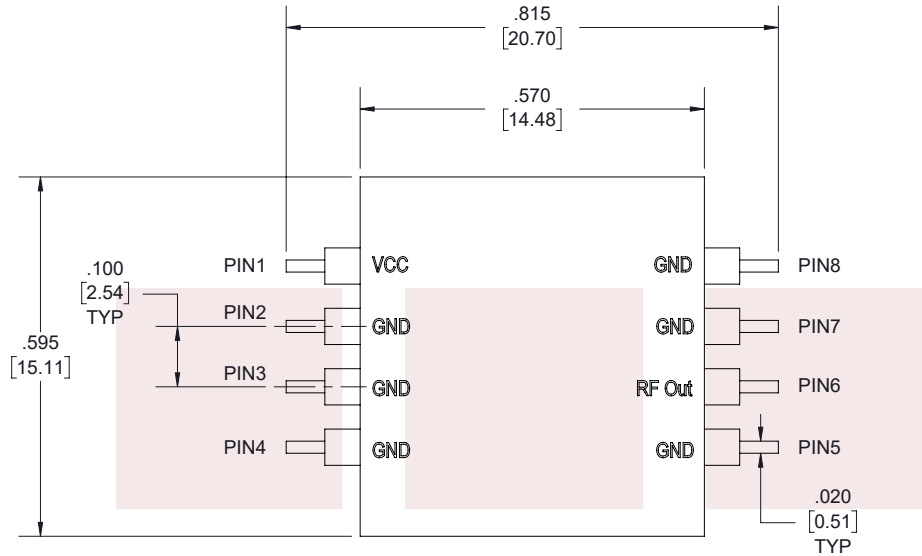

LABEL:

FAIRVIEW MICROWAVE
FMNS4002
D/C: YYWW

THESE COMMODITIES, TECHNOLOGY OR SOFTWARE WERE EXPORTED FROM THE UNITED STATES IN ACCORDANCE WITH THE EXPORT ADMINISTRATION REGULATIONS. DIVERSION CONTRARY TO U.S. LAW PROHIBITED.

TITLE
0.2 MHz to 3 GHz Surface Mount (SMT) Noise Source Module, Output ENR of 31 dB, +12 VDC, Pin Packaged

UNLESS OTHERWISE SPECIFIED LEADING DIMENSIONS ARE INCHES
DIMENSIONS IN [] ARE MILLIMETERS

TOLERANCES: CABLE LENGTH (L) TOLERANCES:

.X = ±.2 [5.08]	FRACTIONS	L ≤ 12 [305] = +1 [25] / -0
.XX = ±.02 [.51]	± 1/32	12 [305] < L ≤ 60 [1524] = +2 [51] / -0
.XXX = ±.005 [.13]	ANGLES ± 1°	60 [1524] < L ≤ 120 [3048] = +4 [102] / -0
		120 [3048] < L ≤ 300 [7620] = +6 [152] / -0
		300 [7620] < L = +5%L / -0

THIRD-ANGLE PROJECTION

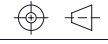

THE INFORMATION AND DESIGN IN THIS DOCUMENT IS THE PROPERTY OF FAIRVIEW MICROWAVE CORPORATION. ALL RIGHTS RESERVED.

SHEET 1 OF 2

ALL DIMENSIONS SHOWN ARE FOR REFERENCE ONLY.

SCALE N/A

SIZE A	CAGE CODE 3FKR5	DRAWN BY K.DANG	ITEM NO. FMNS4002	REV A
-----------	--------------------	--------------------	----------------------	----------

T-Rev.D

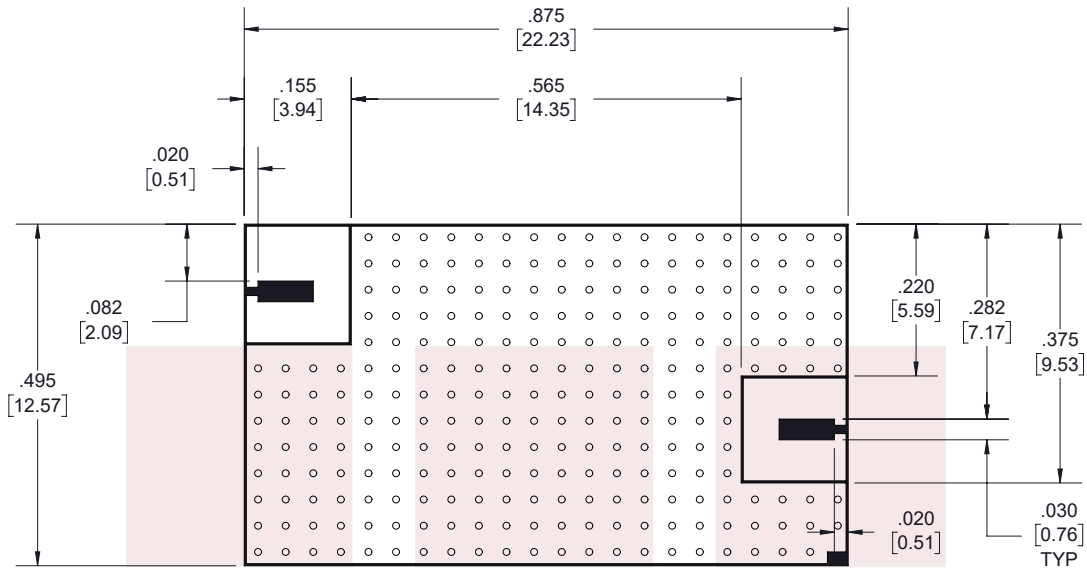

PAD LAYOUT

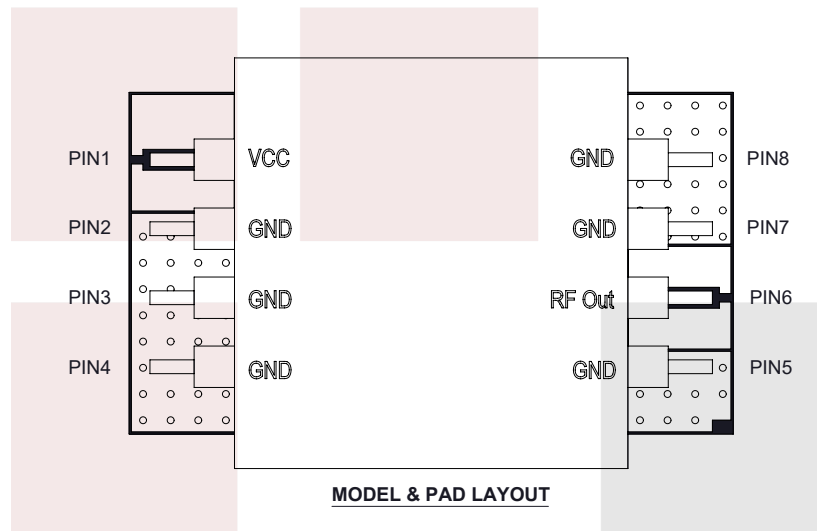



MODEL & PAD LAYOUT

NOTES:

1. Via pattern representative only, use sufficient vias close to ground pins depending on board material and thickness to make an effective ground for the maximum frequency of operation.
2. Dimensions are for guideline use only.

THESE COMMODITIES, TECHNOLOGY OR SOFTWARE WERE EXPORTED FROM THE UNITED STATES IN ACCORDANCE WITH THE EXPORT ADMINISTRATION REGULATIONS. DIVERSION CONTRARY TO U.S. LAW PROHIBITED.

 Fairview Microwave an INFINIT [®] brand	UNLESS OTHERWISE SPECIFIED LEADING DIMENSIONS ARE INCHES DIMENSIONS IN [] ARE MILLIMETERS		THIRD-ANGLE PROJECTION 	
	TOLERANCES: CABLE LENGTH (L) TOLERANCES:		THE INFORMATION AND DESIGN IN THIS DOCUMENT IS THE PROPERTY OF FAIRVIEW MICROWAVE CORPORATION. ALL RIGHTS RESERVED.	
TITLE 0.2 MHz to 3 GHz Surface Mount (SMT) Noise Source Module, Output ENR of 31 dB, +12 VDC, Pin Packaged	.X = ±.2 [5.08] FRACTIONS L ≤ 12 [305] = +1 [25] / -0 .XX = ±.02 [.51] ± 1/32 12 [305] < L ≤ 60 [1524] = +2 [51] / -0 .XXX = ±.005 [.13] ANGLES ± 1° 60 [1524] < L ≤ 120 [3048] = +4 [102] / -0 120 [3048] < L ≤ 300 [7620] = +6 [152] / -0 300 [7620] < L = +5%L / -0	SHEET 2 OF 2		
	ALL DIMENSIONS SHOWN ARE FOR REFERENCE ONLY.			SCALE N/A
SIZE A	CAGE CODE 3FKR5	DRAWN BY K.DANG	ITEM NO. FMNS4002	REV A

T-Rev.D