

LABEL:

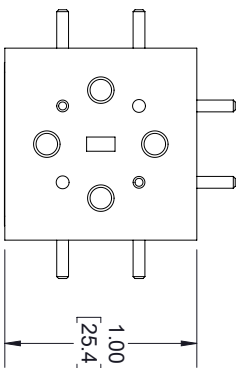

PORT 4
"DIFFERENCE"

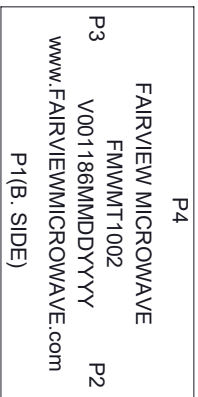
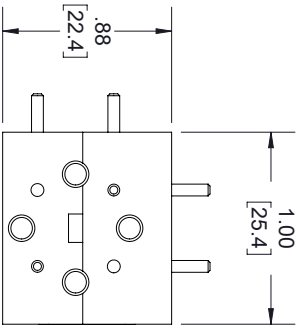
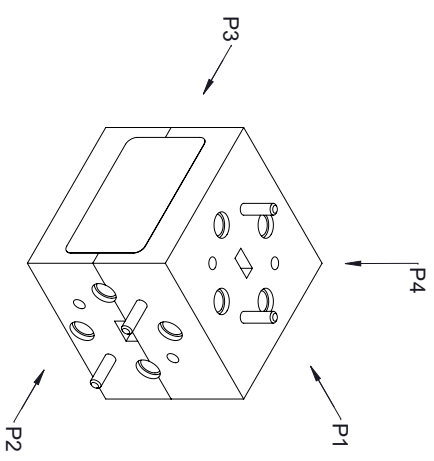

PORT 3
"COLLINEAR"

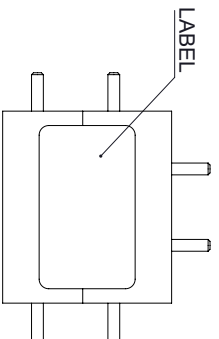

FRONT

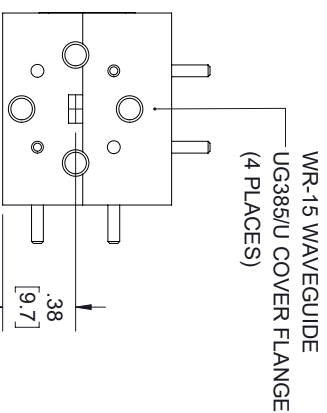

PORT 2
"COLLINEAR"

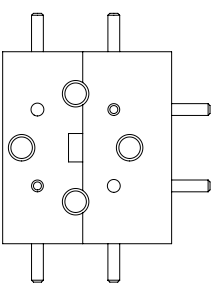

PORT 1
"SUM"

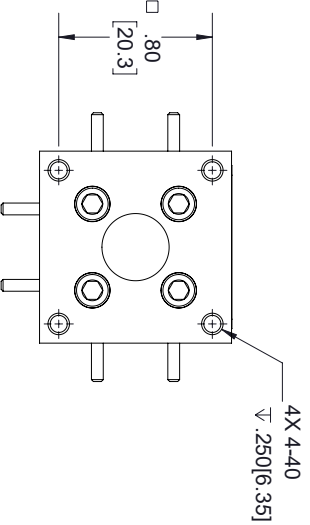

BOTTOM

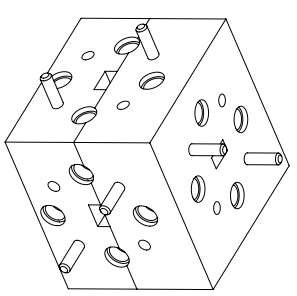

| STANDARD TOLERANCES | |
|---------------------|--------|
| .X | ±0.2 |
| .XX | ±0.01 |
| .XXX | ±0.005 |

*STANDARD TOLERANCES APPLY ONLY TO DIMENSIONS IN INCHES

FAIRVIEW MICROWAVE INC.

ALLEN, TX 75013 WWW.FAIRVIEWMICROWAVE.COM

NOTES:
1. UNLESS OTHERWISE SPECIFIED ALL DIMENSIONS ARE NOMINAL.
2. ALL SPECIFICATIONS ARE SUBJECT TO CHANGE WITHOUT NOTICE AT ANY TIME.
3. DIMENSIONS ARE IN INCHES [mm].

| TITLE | | DWG NO | | CAGE CODE | |
|----------|--------|-----------|--------|-----------|------|
| | | FMWMT1002 | | 3FKR5 | |
| CAD FILE | 111417 | SHEET | 1 OF 1 | SCALE | N/A |
| | | SIZE | A | | 7361 |