

LABEL:

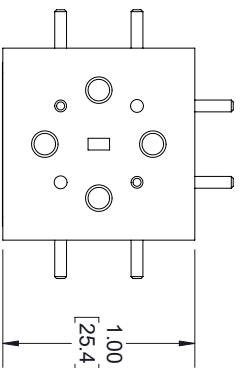

PORT 4
"DIFFERENCE"

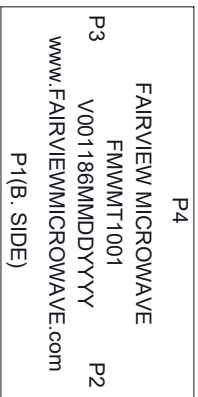
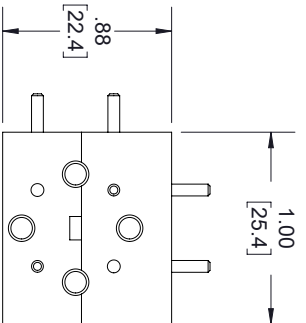
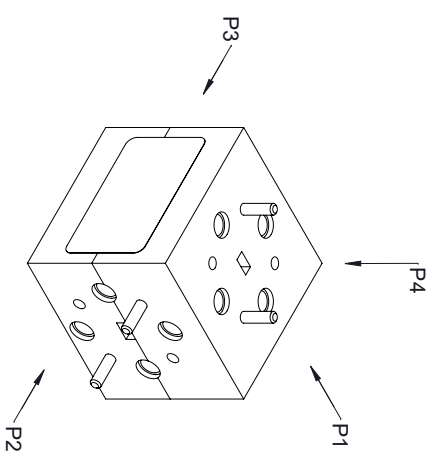

PORT 3
"COLLINEAR"

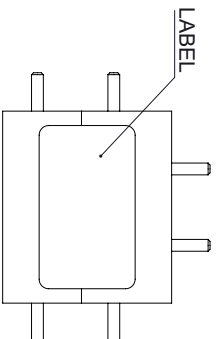

FRONT

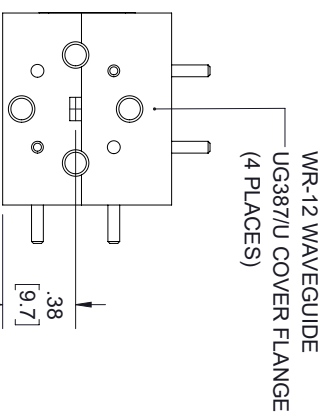

PORT 2
"COLLINEAR"

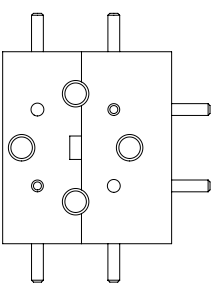

PORT 1
"SUM"

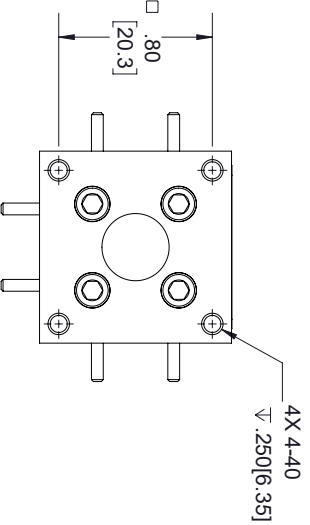

BOTTOM

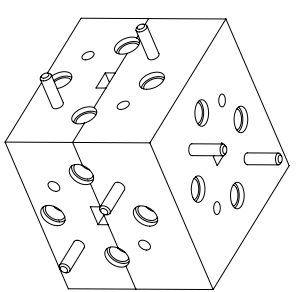

STANDARD TOLERANCES

.X	±0.2
.XX	±0.01
.XXX	±0.005

*STANDARD TOLERANCES APPLY ONLY TO DIMENSIONS IN INCHES

FAIRVIEW MICROWAVE INC.

ALLEN, TX 75013 WWW.FAIRVIEWMICROWAVE.COM

NOTES:
1. UNLESS OTHERWISE SPECIFIED ALL DIMENSIONS ARE NOMINAL.
2. ALL SPECIFICATIONS ARE SUBJECT TO CHANGE WITHOUT NOTICE AT ANY TIME.
3. DIMENSIONS ARE IN INCHES [mm].

TITLE		DWG NO		CAGE CODE	
		FMWMT1001		3FKR5	
CAD FILE	111417	SHEET	1 OF 1	SCALE	N/A
		SIZE	A		7361