

REVISIONS			
REV.	DESCRIPTION	DATE	APPROVED
A	INITIAL RELEASE	23-08-2021	SPONG

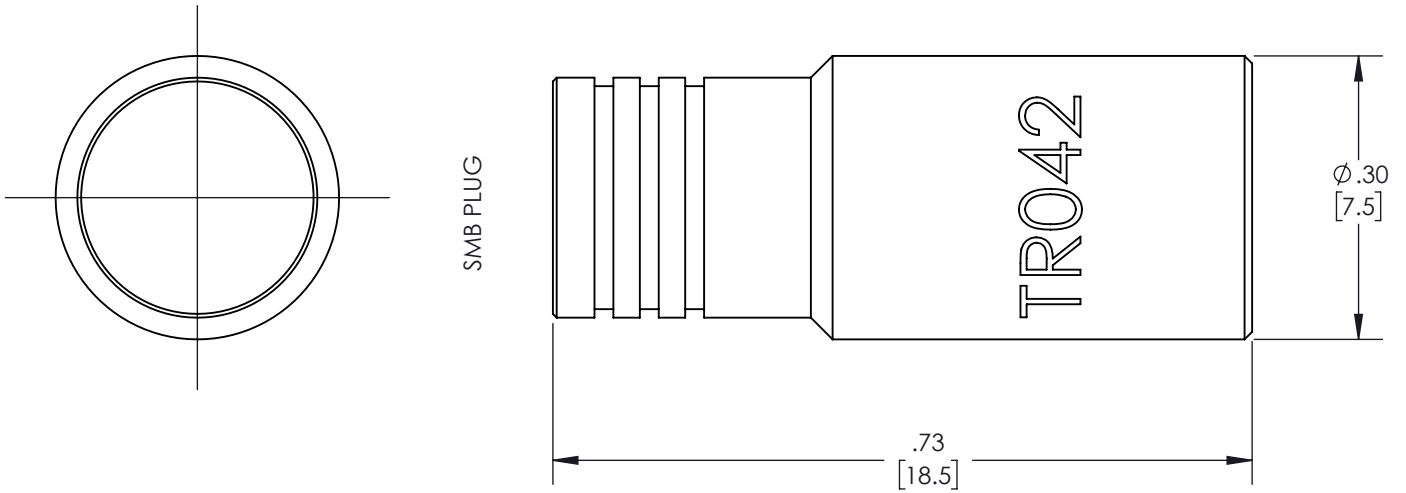

THESE COMMODITIES, TECHNOLOGY OR SOFTWARE WERE EXPORTED FROM THE UNITED STATES IN ACCORDANCE WITH THE EXPORT ADMINISTRATION REGULATIONS. DIVERSION CONTRARY TO U.S. LAW PROHIBITED.



TITLE

UNLESS OTHERWISE SPECIFIED LEADING DIMENSIONS ARE INCHES
DIMENSIONS IN [] ARE MILLIMETERS

TOLERANCES: CABLE LENGTH (L) TOLERANCES:

.X = ±.2 [5.08]	FRACTIONS	L ≤ 12 [305] = +1 [25] / -0
.XX = ±.02 [.51]	± 1/32	12 [305] < L ≤ 60 [1524] = +2 [51] / -0
.XXX = ±.005 [.13]	ANGLES ± 1°	60 [1524] < L ≤ 120 [3048] = +4 [102] / -0
		120 [3048] < L ≤ 300 [7620] = +6 [152] / -0
		300 [7620] < L = +5%L / -0

THIRD-ANGLE PROJECTION



THE INFORMATION AND DESIGN IN THIS DOCUMENT IS THE PROPERTY OF FAIRVIEW MICROWAVE CORPORATION. ALL RIGHTS RESERVED.

SHEET 1 OF 1

ALL DIMENSIONS SHOWN ARE FOR REFERENCE ONLY.

SCALE N/A

SIZE A	CAGE CODE 3FKR5	DRAWN BY MVEERAPPAN	ITEM NO. FMTR042	REV A
-----------	--------------------	------------------------	---------------------	----------