

6

5

4

3

2

1

REVISION

ZONE	REV	DESCRIPTION	DATE	CHANGED BY	APPROVED
	B	ECO-13942	12/19/2024	KDANG	SRAUTUS

F

F

E

E

D

D

C

C

B

B

A

A

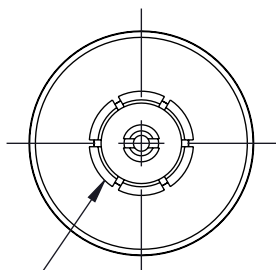

FITS IN CAVITIES THAT ACCEPT
FLOAT MOUNTED VITA 67.3 CONNECTORS
SEE VITA 67.3 MODULES

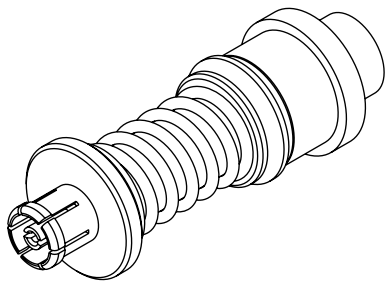
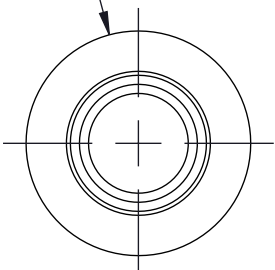
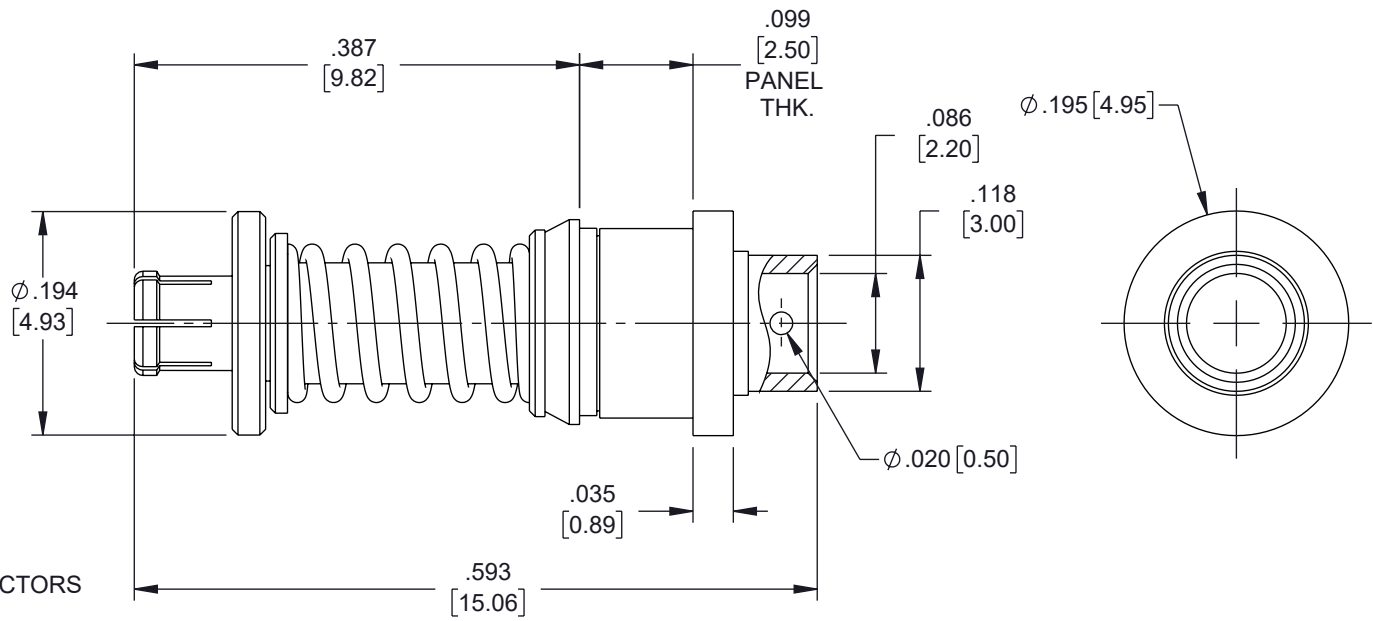

UNLESS OTHERWISE SPECIFIED
LEADING DIMENSIONS ARE INCHES
DIMENSIONS IN [] ARE MILLIMETERS

TOLERANCES:
X = ±.2 [5] FRACTIONS ± 1/32
XX = ±.02 [0.5] ANGLES ± 1°
.XXX = ±.005 [0.13]

CABLE LENGTH TOLERANCES:
≤12 [305] = +1 [25] / -0
>12 [305] ≤ 60 [1524] = +2 [51] / -0
>60 [1524] ≤ 120 [3048] = +4 [102] / -0
>120 [3048] ≤ 300 [7620] = +6 [152] / -0
>300 [7620] = +5% / -0

ALL DIMENSIONS ARE FOR REFERENCE ONLY
AND SUBJECT TO CHANGE WITHOUT NOTICE
UN-DIMENSIONED/NON-CRITICAL FEATURES
MAY VARY IN SIZE AND LOCATION
COLORS MAY VARY



Website: www.FairviewMicrowave.com
Phone: 1.800.715.4396 | 1.972.649.6678

SCALE	SHEET
NONE	1 OF 2

DESCRIPTION
**Mini-SMP (SMPM) FEMALE VITA 67.3 BACKPLANE CONTACT
FOR .086" CABLE**

THE INFORMATION CONTAINED IN THIS DRAWING IS THE SOLE PROPERTY OF INFINITE ELECTRONICS, INC. ANY REPRODUCTION IN PART OR WHOLE WITHOUT THE WRITTEN PERMISSION OF INFINITE ELECTRONICS, INC. IS PROHIBITED. THESE COMMODITIES, TECHNOLOGY OR SOFTWARE WERE EXPORTED FROM THE UNITED STATES IN ACCORDANCE WITH THE EXPORT ADMINISTRATION REGULATIONS. DIVERSION CONTRARY TO U.S. LAW PROHIBITED.

SIZE	CAGE CODE	DRAWN BY	ITEM NO.	REV
A	3FKR5	LNAGARAJ	FMCN49816	B

6

5

4

3

2

1

6 5 4 3 2 1

F
E
D
C
B
A

F
E
D
C
B
A

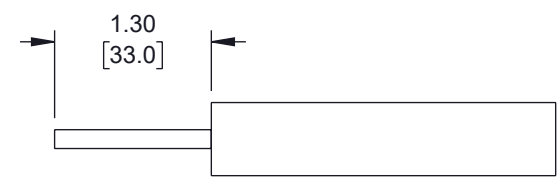
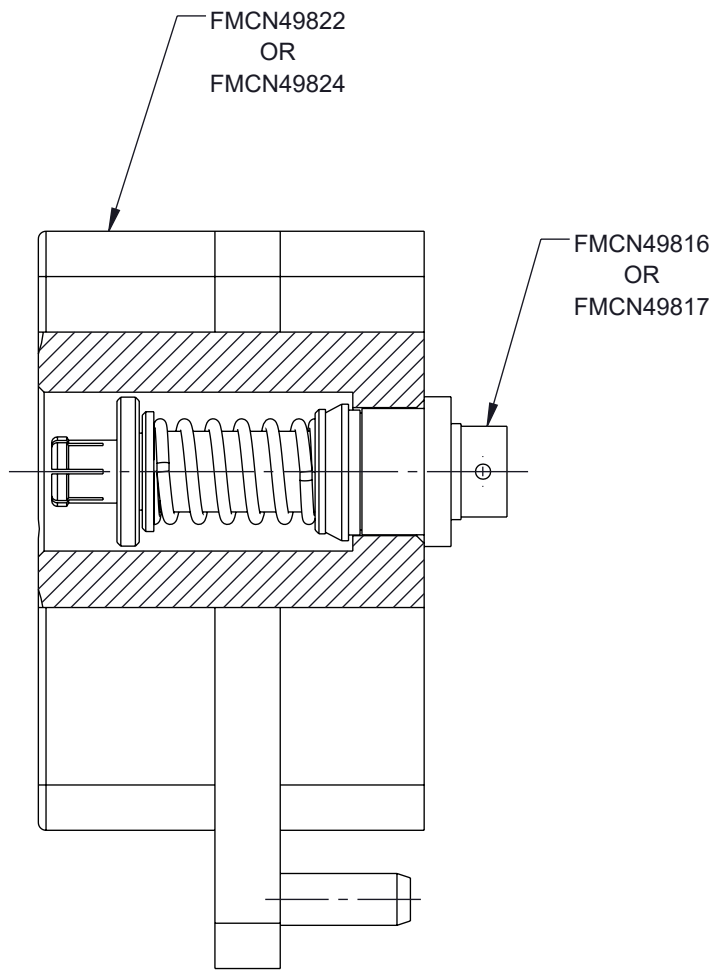



STRIPPING DIMENSIONS

ASSEMBLY PROCEDURES:

1. STRIP CABLE AS SHOWN. DO NOT NICK INNER CONDUCTOR.
2. INSERT CABLE THRU ADAPTER UNTIL IT BOTTOMS, SOLDER

THE INFORMATION CONTAINED IN THIS DRAWING IS THE SOLE PROPERTY OF INFINITE ELECTRONICS, INC. ANY REPRODUCTION IN PART OR WHOLE WITHOUT THE WRITTEN PERMISSION OF INFINITE ELECTRONICS, INC. IS PROHIBITED. THESE COMMODITIES, TECHNOLOGY OR SOFTWARE WERE EXPORTED FROM THE UNITED STATES IN ACCORDANCE WITH THE EXPORT ADMINISTRATION REGULATIONS. DIVERSION CONTRARY TO U.S. LAW PROHIBITED.

ALL DIMENSIONS ARE FOR REFERENCE ONLY AND SUBJECT TO CHANGE WITHOUT NOTICE UN-DIMENSIONED/NON-CRITICAL FEATURES MAY VARY IN SIZE AND LOCATION COLORS MAY VARY

 Fairview Microwave® an INFINIT@ brand		 INTERPRET ALL DIMENSIONS AND TOLERANCES PER ASME Y14.5	
Website: www.FairviewMicrowave.com Phone: 1.800.715.4396 1.972.649.6678		SCALE	SHEET
		NONE	2 OF 2
DESCRIPTION			
Mini-SMP (SMPM) FEMALE VITA 67.3 BACKPLANE CONTACT FOR .086" CABLE			
SIZE	CAGE CODE	DRAWN BY	ITEM NO.
A	3FKR5	LNAGARAJ	FMCN49816
			REV
			B

6 5 4 3 2 1