

STANDARD TOLERANCES
 .X ±0.2
 .XX ±0.01
 .XXX ±0.005

*STANDARD TOLERANCES APPLY ONLY TO DIMENSIONS IN INCHES

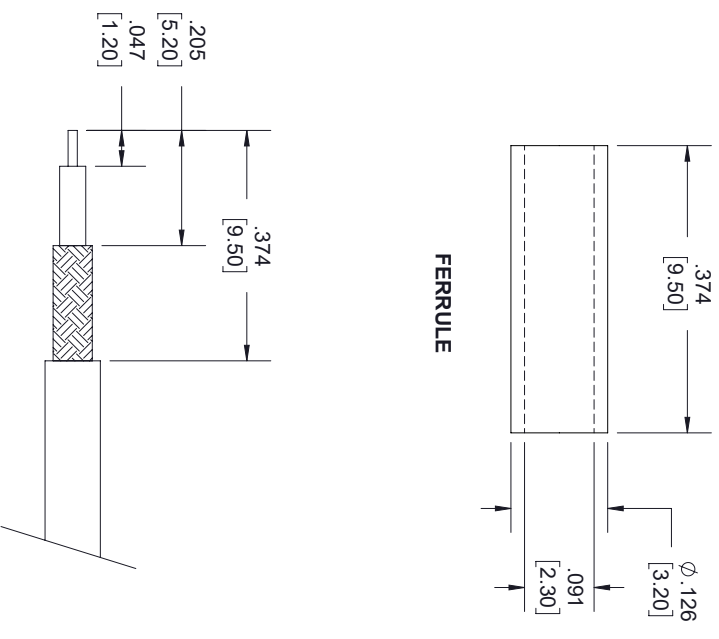

STRIPPING DIMENSIONS

- NOTES:
- CABLE ATTACHMENT:
 - OUTER: CRIMP.
 - INNER: SOLDER.
 - CRIMP SIZE REQUIRED:
 - FERRULE: .100 [2.54] HEX. CRIMP TOOL.
 - CONTACT: SOLDER.



NOTES:
 1. UNLESS OTHERWISE SPECIFIED ALL DIMENSIONS ARE NOMINAL.
 2. ALL SPECIFICATIONS ARE SUBJECT TO CHANGE WITHOUT NOTICE AT ANY TIME.
 3. DIMENSIONS ARE IN INCHES [mm].

TITLE	DWG NO		CAGE CODE					
	FMCN1550		3FKR5					
CAD FILE	06/07/19	SHEET	1 OF 1	SCALE	N/A	SIZE	A	7361