

DETAIL B

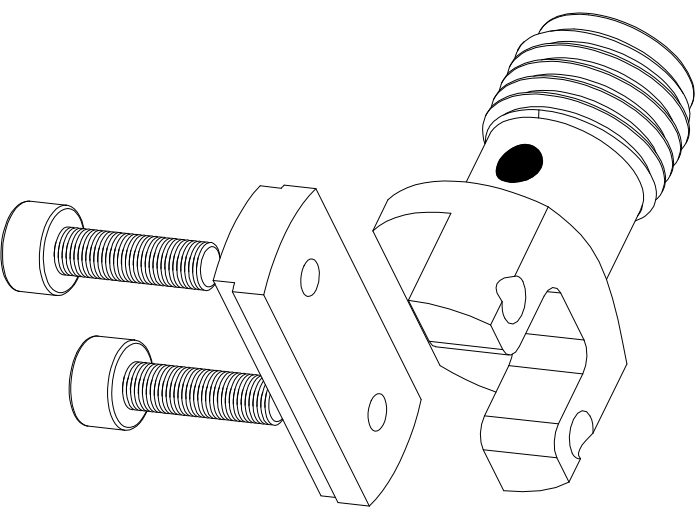

STANDARD TOLERANCES
 .X ±0.2
 .XX ±0.01
 .XXX ±0.005

*STANDARD TOLERANCES APPLY ONLY TO DIMENSIONS IN INCHES

FAIRVIEW MICROWAVE INC.

ALLEN, TX 75013 WWW.FAIRVIEWMICROWAVE.COM

NOTES:
 1. UNLESS OTHERWISE SPECIFIED ALL DIMENSIONS ARE NOMINAL.
 2. ALL SPECIFICATIONS ARE SUBJECT TO CHANGE WITHOUT NOTICE AT ANY TIME.
 3. DIMENSIONS ARE IN INCHES [mm].

TITLE		DWG NO		CAGE CODE	
		FMCN1487		3FKR5	
CAD FILE	06/04/18	SHEET		SCALE	N/A
				SIZE	A
					CN2379