

6 5 4 3 2 1

REVISION					
ZONE	REV	DESCRIPTION	DATE	CHANGED BY	APPROVED
	B	ECO-13202	04/30/2024	KGLEBOVA	KHIETPAS

F F

E E

D D

C C

B B

A A

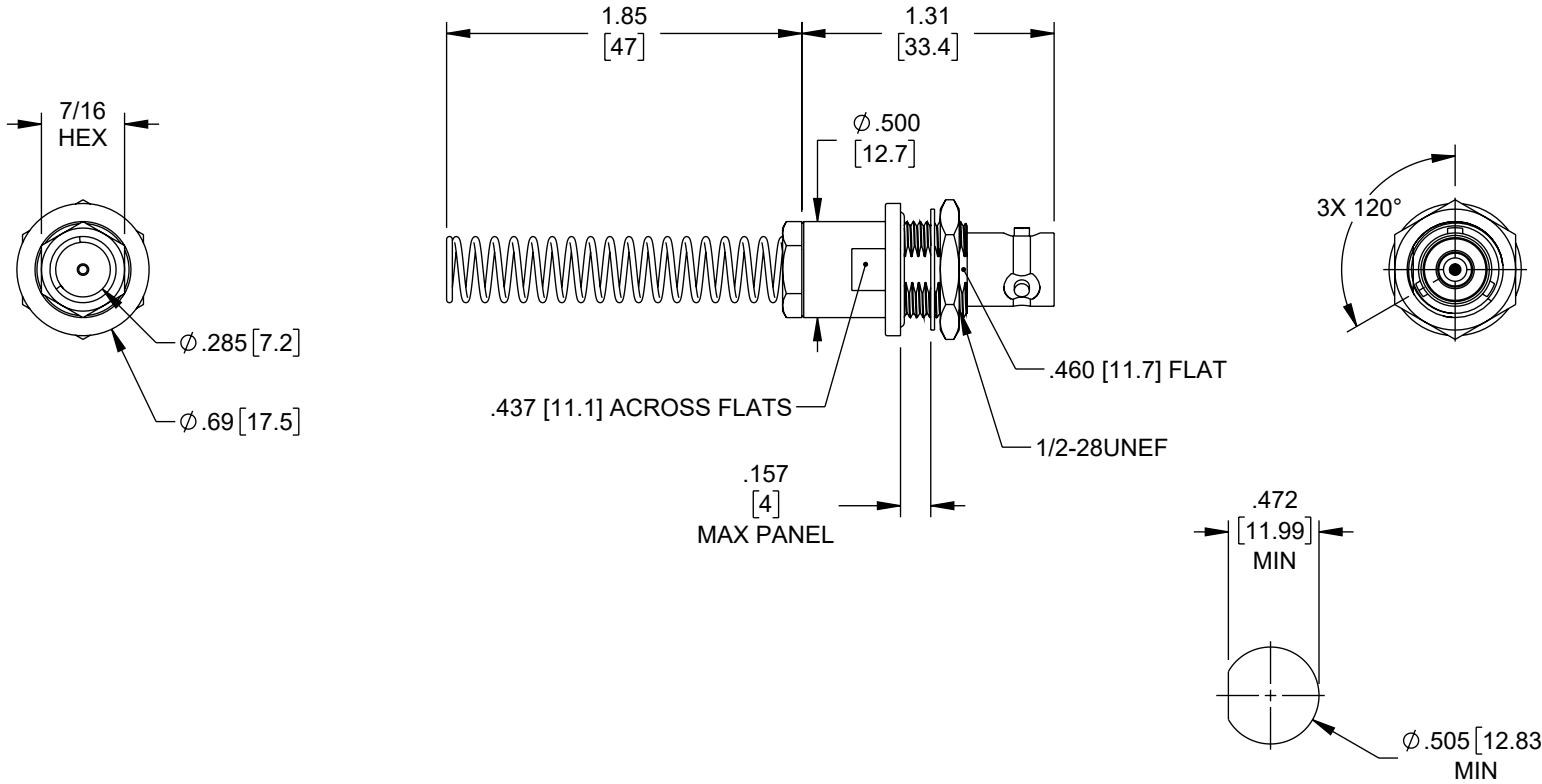

RECOMMENDED MOUNTING HOLE FOR REFERENCE ONLY

UNLESS OTHERWISE SPECIFIED LEADING DIMENSIONS ARE INCHES DIMENSIONS IN [ ] ARE MILLIMETERS

TOLERANCES:

X = ±.2 [5]	FRACTIONS ± 1/32
XX = ±.02 [0.5]	ANGLES ± 1°
.XXX = ±.005 [0.13]	

CABLE LENGTH TOLERANCES:

≤12 [305]	= +1 [25] / -0
>12 [305] ≤ 60 [1524]	= +2 [51] / -0
>60 [1524] ≤ 120 [3048]	= +4 [102] / -0
>120 [3048] ≤ 300 [7620]	= +6 [152] / -0
>300 [7620]	= +5% / -0

ALL DIMENSIONS ARE FOR REFERENCE ONLY AND SUBJECT TO CHANGE WITHOUT NOTICE UN-DIMENSIONED/NON-CRITICAL FEATURES MAY VARY IN SIZE AND LOCATION COLORS MAY VARY



Website: [www.FairviewMicrowave.com](http://www.FairviewMicrowave.com)  
Phone: 1.800.715.4396 | 1.972.649.6678



INTERPRET ALL DIMENSIONS AND TOLERANCES PER ASME Y14.5

SCALE	SHEET
NONE	1 OF 2

DESCRIPTION  
78 OHM TRB 3-LUG NI BULKHEAD JACK 1553 CONNECTOR CLAMP/SOLDER ATTACHMENT WITH BEND RELIEF FOR FMBC-30-02001, TWC-78-2 (OD .242")

SIZE	CAGE CODE	DRAWN BY	ITEM NO.	REV
A	3FKR5	SREITER	FMCN10-06579-210	B

THE INFORMATION CONTAINED IN THIS DRAWING IS THE SOLE PROPERTY OF INFINITE ELECTRONICS, INC. ANY REPRODUCTION IN PART OR WHOLE WITHOUT THE WRITTEN PERMISSION OF INFINITE ELECTRONICS, INC. IS PROHIBITED. THESE COMMODITIES, TECHNOLOGY OR SOFTWARE WERE EXPORTED FROM THE UNITED STATES IN ACCORDANCE WITH THE EXPORT ADMINISTRATION REGULATIONS. DIVERSION CONTRARY TO U.S. LAW PROHIBITED.

# ASSEMBLY INSTRUCTIONS

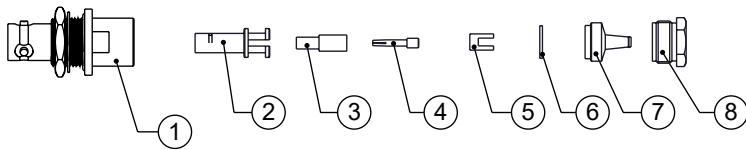

- ① BODY ASSEMBLY
- ② INNER SHIELD
- ③ DIELECTRIC
- ④ CONTACT
- ⑤ NOTCHED INSERT
- ⑥ INSULATING WASHER
- ⑦ CONE
- ⑧ CLAMP NUT

## STEP 1

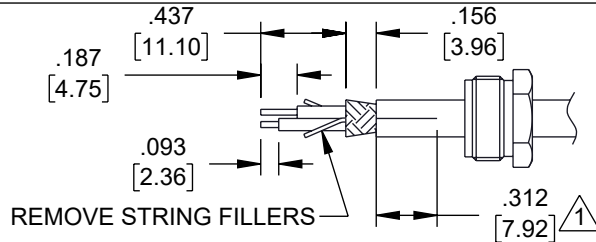

- PLACE ⑧ ONTO CABLE.
- STRIP CABLE AS SHOWN AND FLARE BRAID TO ALLOW FREE ENTER OF ⑦. (▲ LATERAL SLITS 180° APART MAY BE REQUIRED FOR INFLEXIBLE JACKET MATERIALS). LIGHTLY TIN CENTER CONDUCTOR.
- 

## STEP 2

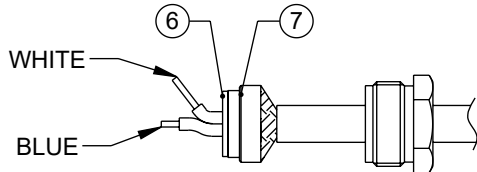

- PUSH ⑦ UNDER BRAID UNTIL BRAID IS FLUSH WITH EDGE OF ⑦.
- INSTALL ⑥ OVER CONDUCTORS AND SEAT AGAINST ⑦.
- BEND LONGER BARED CONDUCTOR AT RIGHT ANGLE AND POSITION OTHER CONDUCTOR TO CENTER OF CABLE.

## STEP 3

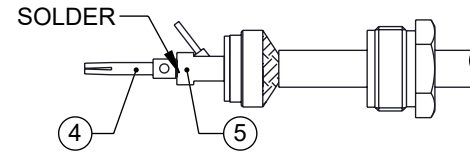

- PLACE ⑤ OVER CONDUCTORS WITH CENTER CONDUCTOR THRU CENTER HOLE AND OTHER CONDUCTOR THRU SIDE SLOT UNTIL SEATED AGAINST ⑥ OR ⑦.
- INSTALL ④ OVER CENTER CONDUCTOR. SEAT AGAINST ⑤ AND SOLDER IN PLACE.

## STEP 4

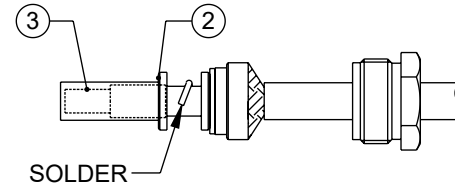

- PLACE ③ OVER ④ UNTIL BOTTOMED.
- INSTALL ② OVER ③ & ⑤ WITH CONDUCTOR THRU SIDE SLOT UNTIL BOTTOMED.
- WRAP CONDUCTOR BETWEEN ② RIDGES AND SOLDER. BEING CAREFUL NOT TO ALLOW SOLDER OR CONDUCTOR TO EXTEND ABOVE ② RIDGES.

## STEP 5

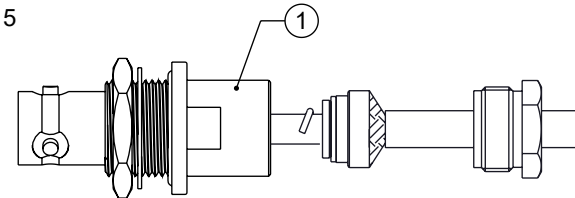

- BRING ⑧ UP ONTO TAPERED PORTION OF CABLE.
- ASSEMBLE ① OVER ENTIRE ASSY AND ENGAGE WITH ⑧.
- WRENCH TIGHTEN TO 25-35 IN LBS TORQUE.

### NOTES:

- THE STRING NOT SHOWN.

THE INFORMATION CONTAINED IN THIS DRAWING IS THE SOLE PROPERTY OF INFINITE ELECTRONICS, INC. ANY REPRODUCTION IN PART OR WHOLE WITHOUT THE WRITTEN PERMISSION OF INFINITE ELECTRONICS, INC. IS PROHIBITED. THESE COMMODITIES, TECHNOLOGY OR SOFTWARE WERE EXPORTED FROM THE UNITED STATES IN ACCORDANCE WITH THE EXPORT ADMINISTRATION REGULATIONS. DIVERSION CONTRARY TO U.S. LAW PROHIBITED.

ALL DIMENSIONS ARE FOR REFERENCE ONLY AND SUBJECT TO CHANGE WITHOUT NOTICE UN-DIMENSIONED/NON-CRITICAL FEATURES MAY VARY IN SIZE AND LOCATION COLORS MAY VARY

**Fairview Microwave**  
an INFINIT@ brand

Website: [www.FairviewMicrowave.com](http://www.FairviewMicrowave.com)  
Phone: 1.800.715.4396 | 1.972.649.6678

INTERPRET ALL DIMENSIONS AND TOLERANCES PER ASME Y14.5  
SCALE NONE SHEET 2 OF 2

DESCRIPTION  
78 OHM TRB 3-LUG NI BULKHEAD JACK 1553 CONNECTOR CLAMP/SOLDER ATTACHMENT WITH BEND RELIEF FOR FMBC-30-02001, TWC-78-2 (OD .242")

SIZE A	CAGE CODE 3FKR5	DRAWN BY SREITER	ITEM NO. FMCN10-06579-210	REV B
-----------	--------------------	---------------------	------------------------------	----------