

STANDARD TOLERANCES
 .X ±0.2
 .XX ±0.01
 .XXX ±0.005

*STANDARD TOLERANCES APPLY
 ONLY TO DIMENSIONS IN INCHES

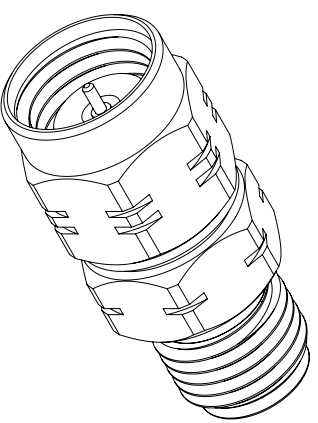

NOTES:
 1. UNLESS OTHERWISE SPECIFIED ALL DIMENSIONS ARE NOMINAL.
 2. ALL SPECIFICATIONS ARE SUBJECT TO CHANGE WITHOUT NOTICE AT ANY TIME.
 3. DIMENSIONS ARE IN INCHES [mm].

TITLE		DWG NO		CAGE CODE	
FMAD1202		FMAD1202		3FKR5	
CAD FILE	05/09/18	SHEET	1 OF 1	SCALE	N/A
		SIZE	A		7361