

LABEL

FAIRVIEW MICROWAVE
FM2CP1127-10
 D/C: XXXX

STANDARD TOLERANCES
 .X ±0.2
 .XX ±0.01
 .XXX ±0.005

*STANDARD TOLERANCES APPLY ONLY TO DIMENSIONS IN INCHES

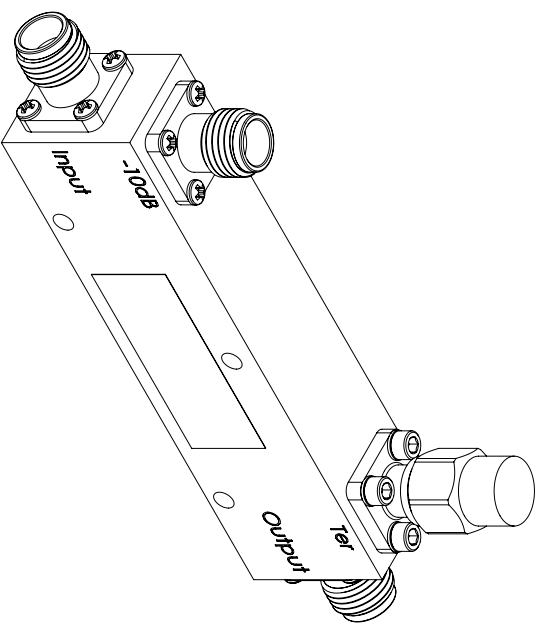

NOTES:
 1. UNLESS OTHERWISE SPECIFIED ALL DIMENSIONS ARE NOMINAL.
 2. ALL SPECIFICATIONS ARE SUBJECT TO CHANGE WITHOUT NOTICE AT ANY TIME.
 3. DIMENSIONS ARE IN INCHES [mm].

TITLE		DWG NO		CAGE CODE	
		FM2CP1127-10		3FKR5	
CAD FILE	04/17/19	SHEET	1 OF 1	SCALE	N/A
				SIZE	A
					7361